

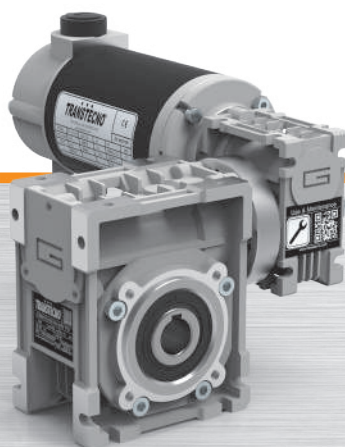

Ferrite

Motoriduttori CC a vite senza fine combinati
DC double reduction wormgearmotors





Indice	Index	Pag. Page
Caratteristiche tecniche	<i>Technical features</i>	Q2
Designazione	<i>Classification</i>	Q2
Simbologia	<i>Symbols</i>	Q2
Esecuzioni di montaggio	<i>Mounting executions</i>	Q2
Combinazioni rapporti	<i>Combination ratio</i>	Q3
Lubrificazione	<i>Lubrication</i>	Q3
Dati tecnici per servizio S2	<i>Technical data for S2 duty</i>	Q4
Motori applicabili	<i>Motor adapters</i>	Q9
Dimensioni	<i>Dimensions</i>	Q10
Opzioni	<i>Options</i>	Q24
Accessori	<i>Accessories</i>	Q25

Questa sezione annulla e sostituisce ogni precedente edizione o revisione. Qualora questa sezione non Vi sia giunta in distribuzione controllata, l'aggiornamento dei dati ivi contenuto non è assicurato. **In tal caso la versione più aggiornata è disponibile sul nostro sito internet www.transtecno.com**

This section replaces any previous edition and revision. If you obtained this catalogue other than through controlled distribution channels, the most up to date content is not guaranteed. In this case the latest version is available on our web site www.transtecno.com

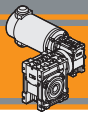

ECMM

Motoriduttori CC a vite senza fine combinati DC Double reduction wormgearmotors

Caratteristiche tecniche

Technical features

Le caratteristiche principali dei motoriduttori CC a vite senza fine combinati a magneti permanenti in ferrite serie ECMM sono:

The main features of ECMM ferrite permanent magnets DC reduction wormgearmotors range are:

- Alimentazione in bassa tensione 12/24Vcc
- Possibilità di montaggio encoder
- Potenze motore disponibili da 100 a 800W S2
- Magneti in ferrite
- Carcassa in pressofusione di alluminio nelle grandezze 026, 030, 040, 050, 063, 075, 090 e 110. La grandezza 130 è costruita con carcassa in ghisa
- Lubrificazione permanente con olio sintetico
- Low voltage power supply 12/24Vdc
- Suitable for encoder assembly
- Motor power ratings available from 100 up to 800W S2
- Ferrite magnets
- Die cast aluminium housing on sizes 026, 030, 040, 050, 063, 075, 090 and 110. Cast iron housing on size 130
- Permanent synthetic oil long life lubrication

Designazione

Classification

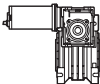
MOTORIDUTTORE / GEARMOTOR													
ECMM	100/026/026				U	150	SZDX	BRSX	90	B3	UB1	120	VS1
Tipo Type	Grandezza Size				Versione Version	Rapporto Ratio	Albero di uscita Output shaft	Braccio di reazione Torque arm	Angolo Angle	Pos. di montaggio Mounting position	Esecuzione di montaggio Mounting execution	Versione motore Motor version	Opzioni Options
	070/026/026	100/026/026	180/026/040	350/030/040	U F...	vedi tabelle see tables	SZDX SZSX DZ	BRDX BRSX *	0° 90° 180° 270°	B3 B8 B6 B7 V5 V6	UB1 UB2 US1 US2 UV1 UV2 UC1 UC2	120 240 24E	VS1 VS2
	070/026/026 (D11)	100/026/026 (D11)	180/026/050	350/030/050									
	070/026/026 (D14)	100/026/026 (D14)	180/030/040	350/030/063									
	070/026/030	100/026/030	180/030/050	350/040/070									
	070/026/040	100/026/040	180/030/063	350/040/075									
	070/026/050	100/026/050	180/040/070	350/040/090									
	070/030/040	100/030/040	180/040/075	350/050/110									
	070/030/050	100/030/050	180/040/090	350/063/130									
	070/030/063	100/030/063	180/050/110										
	070/040/070	100/040/075	250/030/040	600/040/070									
	070/040/075	100/040/090	250/030/050	600/040/075									
	070/040/090		250/030/063	600/040/090									
			250/040/070	600/050/110									
			250/040/075	600/063/130									
			250/040/090										
			250/050/110										

* NOTA: il braccio di reazione viene fornito smontato.
NOTE: the torque arm will be supplied not assembled.

Versione Riduttore
Gearbox Version

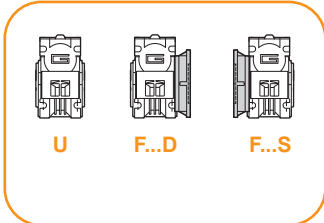

U F..D F..S

Albero di uscita
Output shaft

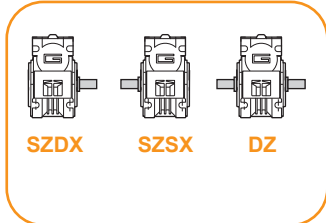

SZDX SZSX DZ

Braccio di reazione
Torque arm

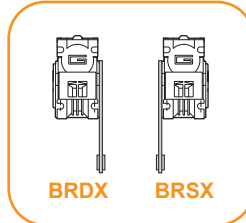

BRDX BRSX

Angolo
Angle

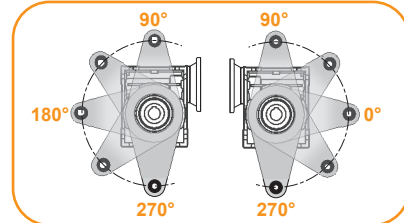

90° 90°
180° 0°
270° 270°

Simbologia

Symbols

n_1 [min ⁻¹]	Velocità in ingresso / Input speed	M_2 [Nm]	Coppia in uscita in funzione di P_1 / Output torque referred to P_1
n_2 [min ⁻¹]	Velocità in uscita / Output speed	sf	Fattore di servizio / Service factor
i	Rapporto di riduzione / Ratio	R_2 [N]	Carico radiale ammissibile in uscita / Permitted output radial load
P_1 [kW]	Potenza in entrata / Input power	A_2 [N]	Carico assiale ammissibile in uscita / Permitted output axial load

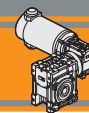

Esecuzioni di montaggio

Mounting executions

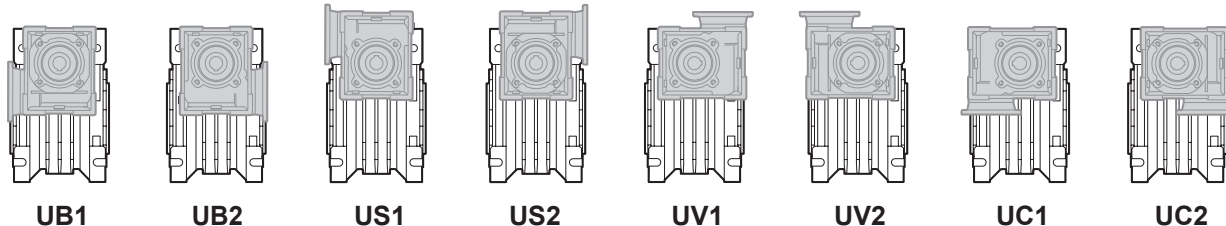

Combinazioni rapporti

Combination ratio

CMM 026/026 - CMM 026/030 - CMM 026/040 - CMM 026/050												
i (i ₁ x i ₂)												
	150	225	300	450	600	900	1200	1500	1800	2400	3000	3600
i ₁	10	15	10	15	20	30	40	50	60	60	60	60
i ₂	15	15	30	30	30	30	30	30	30	40	50	60

CMM 030/040 - CMM 030/050 - CMM 030/063 - CMM 040/070 - CMM 040/075 - CMM 040/090 - CMM 050/110 - CMM 063/130																
i (i ₁ x i ₂)																
	75	100	150	200	250	300	400	500	600	750	900	1200	1500	1800	2400	3000
i ₁	7.5	10	10	10	10	10	10	10	20	25	30	40	50	60	60	60
i ₂	10	10	15	20	25	30	40	50	30	30	30	30	30	30	40	50

Lubrificazione

Lubrication

Tutti i motoriduttori nelle taglie 26, 30, 40, 50, 63, 70, 75, 90, 110 sono forniti completi di lubrificante sintetico viscosità 320, pertanto possono essere installati in qualunque posizione di montaggio e non necessitano di manutenzione. Per la taglia 130 la lubrificazione dipende dalla posizione di montaggio

Permanent synthetic oil long-life lubrication (viscosity grade 320) makes it possible to use the gearmotors size 26, 30, 40, 50, 63, 70, 75, 90, 110 in all mounting positions; for this reason they can be installed in any assembly position and do not require maintenance. Only for size 130, the lubrication depended of mounting positions

Quantità di olio (litri) / Oil quantity (litres)						
	M1 (B3)	M3 (B8)	M6 (B6)	M5 (B7)	M4 (V5)	M2 (V6)
CM130	4.5	3.3	3.5	3.5	4.5	3.3

Lubrificato a vita
Life lubrication

Posizioni di montaggio / Mounting positions

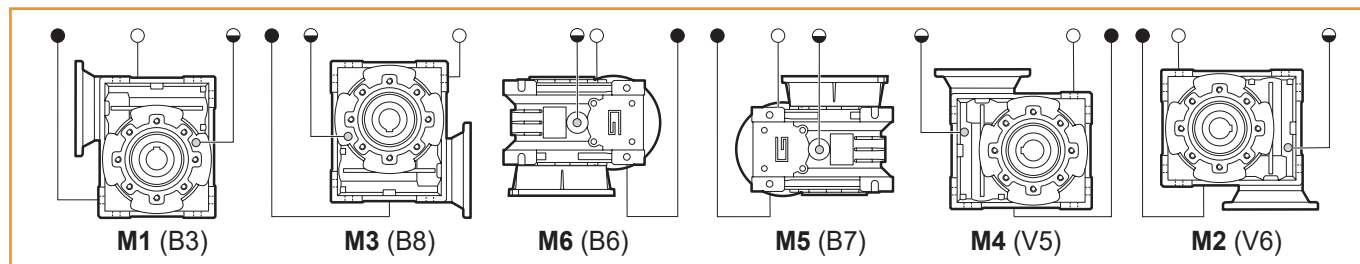

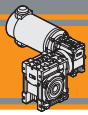

(standard)

- Sfiato e tappo di riempimento / Breather and filling plug
- ◐ Livello olio / Oil level plug
- Tappo di scarico / Oil drain plug



Dati tecnici per servizio S2

Technical data for S2 duty

P_1 [W]	n_2 [min ⁻¹]	M_2 [Nm]	sf	i		Versione motore Motor version	P_1 [W]	n_2 [min ⁻¹]	M_2 [Nm]	sf	i		Versione motore Motor version			
100							100									
(3000 min ⁻¹)	20.0	26	1.0	150	ECMM 070/026/026	12E/24E	(3000 min ⁻¹)	40.0	15	5.5	75	ECMM 070/030/040	12E/24E			
	13.3	26	1.0	225		120.66/240.66			30.0	20	4.2		100	120.66/240.66		
	10.0	27	1.0	300					20.0	28	3.2		150			
	6.7	27	1.0	450					15.0	36	2.1		200			
	5.0	27	1.0	600					12.0	43	1.6		250			
	3.3	27	1.0	900					10.0	46	2.0		300			
	2.5	27	1.0	1200					7.5	55	1.3		400			
	2.0	27	1.0	1500					6.0	63	1.1		500			
	1.7	27	1.0	1800					5.0	86	1.0		600			
	1.3	22	1.0	2400					4.0	103	0.9		750			
	1.0	20	1.0	3000					3.3	118	0.8		900			
	0.8	18	1.0	3600					2.5	74	1.0		1200			
									2.0	90	1.0		1500			
									1.7	90	1.0		1800			
									1.3	74	1.0		2400			
									1.0	68	1.0		3000			
	20.0	26	1.5	150		ECMM 070/026/030	12E/24E							ECMM 070/030/050	12E/24E	
	13.3	39	1.0	225			120.66/240.66			15.0	36		7.1		200	12E/24E
	10.0	40	1.0	300					12.0	43	5.8	250	120.66/240.66			
	6.7	40	1.0	450					10.0	46	3.5	300				
	5.0	40	1.0	600					7.5	57	2.4	400				
	3.3	40	1.0	900					6.0	64	2.0	500				
	2.5	40	1.0	1200					5.0	87	1.9	600				
	2.0	40	1.0	1500					4.0	105	1.5	750				
	1.7	40	1.0	1800					3.3	120	1.4	900				
	1.3	34	1.0	2400					2.5	146	0.9	1200				
	1.0	30	1.0	3000					2.0	175	0.9	1500				
	0.8	27	1.0	3600					1.7	201	0.8	1800				
									1.3	135	1.0	2400				
									1.0	125	1.0	3000				
	20.0	27	3.2	150	ECMM 070/026/040		12E/24E						ECMM 070/030/063		12E/24E	
	13.3	40	2.2	225			120.66/240.66			4.0	109	2.4			750	12E/24E
	10.0	45	2.0	300						3.3	124	2.5			900	120.66/240.66
	6.7	66	1.4	450						2.5	149	1.7			1200	
	5.0	85	1.1	600					2.0	181	1.4	1500				
	3.3	90	1.0	900					1.7	208	1.2	1800				
	2.5	90	1.0	1200					1.3	249	1.0	2400				
	2.0	90	1.0	1500					1.0	288	0.8	3000				
	1.7	90	1.0	1800												
	1.3	74	1.0	2400					2.5	155	2.5	1200		ECMM 070/040/070	12E/24E	
	1.0	68	1.0	3000					2.0	193	2.4	1500			120.66/240.66	
	0.8	62	1.0	3600					1.7	221	2.1	1800				
									1.3	265	1.4	2400				
									1.0	307	1.1	3000				
	20.0	28	4.1	150		ECMM 070/026/050	12E/24E							ECMM 070/040/075	12E/24E	
	13.3	42	2.8	225			120.66/240.66			2.5	158	3.0			1200	12E/24E
	10.0	46	3.5	300						2.0	193	2.8			1500	120.66/240.66
	6.7	67	2.4	450					1.7	221	2.5	1800				
	5.0	86	1.9	600					1.3	270	1.7	2400				
	3.3	118	1.4	900					1.0	307	1.3	3000				
	2.5	147	1.1	1200												
	2.0	162	1.0	1500					1.3	285	2.9	2400	ECMM 070/040/090		12E/24E	
	1.7	162	1.0	1800					1.0	331	2.1	3000			120.66/240.66	
	1.3	135	1.0	2400												
	1.0	125	1.0	3000												
	0.8	113	1.0	3600												













N.B.
Verificare sempre che la coppia M2 utilizzata non ecceda il valore indicato nelle caselle in grigio
N.B.
Please check that the output torque M2 does not exceed the value in the grey areas

NOTA: per servizio continuo o altamente intermittente, contattare il servizio tecnico
NOTE: for continuous or highly intermittent duty, please contact our technical service



Dati tecnici per servizio S2

Technical data for S2 duty

P_1 [W]	n_2 [min ⁻¹]	M_2 [Nm]	sf	i		Versione motore Motor version	P_1 [W]	n_2 [min ⁻¹]	M_2 [Nm]	sf	i		Versione motore Motor version					
140							140											
(3000 min ⁻¹)	20.0	26	1.0	150		ECMM 100/026/026 120/240/24E 120.66/240.66	(3000 min ⁻¹)	40.0	21	3.9	75		ECMM 100/030/040 120/240/24E 120.66/240.66					
	13.3	26	1.0	225					30.0	28	3.0			100				
	10.0	27	1.0	300					20.0	38	2.3			150				
	6.7	27	1.0	450					15.0	50	1.5			200				
	5.0	27	1.0	600					12.0	59	1.1			250				
	3.3	27	1.0	900					10.0	63	1.4			300				
	2.5	27	1.0	1200					7.5	77	1.0			400				
	2.0	27	1.0	1500					6.0	87	0.8			500				
	1.7	27	1.0	1800					5.0	119	0.8			600				
	1.3	22	1.0	2400					4.0	90	1.0			750				
	1.0	20	1.0	3000					3.3	90	1.0			900				
	0.8	18	1.0	3600					2.5	74	1.0			1200				
							2.0	90	1.0	1500								
	20.0	37	1.1	150		ECMM 100/026/030 120/240/24E 120.66/240.66		1.7	90	1.0	1800							
	13.3	39	1.0	225					1.3	74	1.0	2400						
	10.0	40	1.0	300					1.0	68	1.0	3000						
	6.7	40	1.0	450														
	5.0	40	1.0	600					15.0	50	2.7	200		ECMM 100/030/050 120/240/24E 120.66/240.66				
	3.3	40	1.0	900					12.0	59	2.1	250						
	2.5	40	1.0	1200					10.0	64	2.5	300						
	2.0	40	1.0	1500					7.5	78	1.7	400						
	1.7	40	1.0	1800					6.0	89	1.4	500						
	1.3	34	1.0	2400					5.0	121	1.3	600						
	1.0	30	1.0	3000					4.0	146	1.1	750						
	0.8	27	1.0	3600					3.3	166	1.0	900						
							2.5	202	0.7	1200								
	20.0	38	2.3	150		ECMM 100/026/040 120/240/24E 120.66/240.66		2.0	243	0.7	1500							
	13.3	55	1.6	225					1.7	162	1.0	1800						
	10.0	63	1.4	300					1.3	135	1.0	2400						
	6.7	92	1.0	450					1.0	125	1.0	3000						
	5.0	90	1.0	600														
	3.3	90	1.0	900					6.0	92	2.5	500		ECMM 100/030/063 120/240/24E 120.66/240.66				
	2.5	90	1.0	1200					5.0	125	1.9	600						
	2.0	90	1.0	1500					4.0	151	1.7	750						
	1.7	90	1.0	1800					3.3	172	1.8	900						
	1.3	74	1.0	2400					2.5	206	1.3	1200						
	1.0	68	1.0	3000					2.0	252	1.0	1500						
	0.8	62	1.0	3600					1.7	288	0.8	1800						
							1.3	346	0.8	2400								
							1.0	232	1.0	3000								
	20.0	39	2.9	150		ECMM 100/026/050 120/240/24E 120.66/240.66		3.3	179	2.5	900				ECMM 100/040/070 120/240/24E* 120.66/240.66			
	13.3	58	2.7	225					2.5	215	1.8					1200		
	10.0	64	2.5	300					2.0	267	1.7					1500		
	6.7	93	1.7	450					1.7	307	1.5		1800					
	5.0	120	1.4	600					1.3	368	1.0		2400					
	3.3	164	1.0	900					1.0	426	0.8		3000					
	2.5	162	1.0	1200														
	2.0	162	1.0	1500					3.3	179	3.1		900			ECMM 100/040/075 120/240/24E* 120.66/240.66		
	1.7	162	1.0	1800					2.5	219	2.2		1200					
	1.3	135	1.0	2400					2.0	267	2.0		1500					
	1.0	125	1.0	3000					1.7	307	1.8		1800					
									1.3	375	1.3		2400					
							1.0	426	0.9	3000								
							1.7	322	2.9	1800		ECMM 100/040/090 120/240/24E* 120.66/240.66						
							1.3	395	1.6	2400								
							1.0	460	1.6	3000								

N.B.
Verificare sempre che la coppia M2 utilizzata non ecceda il valore indicato nelle caselle in grigio
N.B.
Please check that the output torque M2 does not exceed the value in the grey areas

NOTA: per servizio continuo o altamente intermittente, contattare il servizio tecnico







































































NOTE: for continuous or highly intermittent duty, please contact our technical service

*: Motore inclinato con portaspazzola a 45°
Motor assembly with brush holder inclined 45°



Dati tecnici per servizio S2

Technical data for S2 duty

P_1 [W]	n_2 [min ⁻¹]	M_2 [Nm]	sf	i		Versione motore Motor version	P_1 [W]	n_2 [min ⁻¹]	M_2 [Nm]	sf	i		Versione motore Motor version				
250							250										
(3000 min ⁻¹)	20.0	70	1.2	150		ECMM 180/026/040	120/240	(3000 min ⁻¹)	12.0	113	3.6	250		ECMM 180/040/075	120/240*		
	13.3	103	0.8	225			120.66/240.66		10.0	125	4.4	300				24E	
	10.0	116	0.8	300					7.5	153	3.1	400				120.66/240.66	
	20.0	73	1.6	150		ECMM 180/026/050	120/240		6.0	174	2.3	500					
	13.3	108	1.1	225			120.66/240.66		5.0	239	2.3	600					
	10.0	118	1.4	300					4.0	288	1.9	750					
	6.7	173	0.9	450					3.3	333	1.6	900					
	5.0	223	0.7	600					2.5	407	1.2	1200					
	40.0	40	2.1	75			ECMM 180/030/040	120/240/24E		2.0	497	1.1		1500			
	30.0	52	1.6	100			120.66/240.66		1.7	570	1.0	1800					
	20.0	71	1.2	150					1.3	470	1.0	2400					
	15.0	92	0.8	200					1.0	403	1.0	3000					
	12.0	67	1.0	250					5.0	251	2.3	600			ECMM 180/040/090	120/240*	
	10.0	90	1.0	300					4.0	302	1.8	750					24E
	7.5	74	1.0	400				3.3	349	2.1	900				120.66/240.66		
	6.0	68	1.0	500					2.5	429	1.9	1200					
	5.0	90	1.0	600					2.0	522	1.2	1500					
	4.0	90	1.0	750					1.7	599	0.9	1800					
	3.3	90	1.0	900					1.3	735	0.9	2400					
	40.0	40	2.9	75			ECMM 180/030/050	120/240/24E		1.0	855	0.8		3000			
	30.0	52	2.3	100				120.66/240.66		3.3	359	3.6		900			ECMM 180/050/110
	20.0	74	2.2	150					2.5	457	3.2	1200					IEC 63B14
	15.0	94	1.5	200					2.0	545	2.0	1500					
	12.0	110	1.1	250					1.7	627	1.6	1800					
	10.0	120	1.4	300					1.3	796	1.6	2400					
	7.5	146	0.9	400					1.0	947	1.3	3000					
	6.0	165	0.8	500													
	5.0	226	0.7	600													
	4.0	162	1.0	750													
	3.3	162	1.0	900													
	2.5	135	1.0	1200													
	2.0	162	1.0	1500													
	1.7	162	1.0	1800													
	15.0	92	2.3	200			ECMM 180/030/063	120/240/24E		40.0	55		1.5		75		ECMM 250/030/040
	12.0	108	2.1	250			120.66/240.66		30.0	72	1.2	100					120.66/240.66
	10.0	124	2.3	300					20.0	100	0.9	150					
	7.5	149	1.7	400					15.0	74	1.0	200					
	6.0	172	1.3	500					12.0	67	1.0	250					
	5.0	233	1.1	600					10.0	90	1.0	300					
	4.0	281	1.0	750					7.5	74	1.0	400					
	3.3	320	1.0	900					6.0	68	1.0	500					
	2.5	384	0.7	1200					5.0	90	1.0	600					
	2.0	468	0.7	1500					4.0	90	1.0	750					
	1.7	310	1.0	1800					3.3	90	1.0	900					
	1.3	260	1.0	2400					2.5	74	1.0	1200					
	1.0	232	1.0	3000					2.0	90	1.0	1500					
	12.0	113	3.0	250			ECMM 180/040/070	120/240/24E*		40.0	56	2.0	75				ECMM 250/030/050
	10.0	125	3.6	300				120.66/240.66		30.0	73	1.7	100				
	7.5	150	2.5	400					20.0	104	1.5	150					
	6.0	174	1.9	500					15.0	131	1.0	200					
	5.0	239	1.9	600					12.0	154	0.8	250					
	4.0	288	1.8	750					10.0	168	1.0	300					
	3.3	333	1.4	900					7.5	204	0.7	400					
	2.5	399	0.9	1200					6.0	125	1.0	500					
	2.00	497	0.9	1500					5.0	162	1.0	600					
	1.67	570	0.9	1800					4.0	162	1.0	750					
	1.25	379	1.0	2400					3.3	162	1.0	900					
	1.00	336	1.0	3000					2.5	135	1.0	1200					
									2.00	162	1.0	1500					



Solo / Only

*: Motore inclinato con portaspazzole a 45°
Motor assembly with brush holder inclined 45°

N.B.
Verificare sempre che la coppia M2 utilizzata non ecceda il valore indicato nelle caselle in grigio
N.B.
Please check that the output torque M2 does not exceed the value in the grey areas



NOTA: per servizio continuo o altamente intermittente, contattare il servizio tecnico

NOTE: for continuous or highly intermittent duty, please contact our technical service



Dati tecnici per servizio S2

Technical data for S2 duty

P_1 [W]	n_2 [min ⁻¹]	M_2 [Nm]	sf	i		Versione motore Motor version	P_1 [W]	n_2 [min ⁻¹]	M_2 [Nm]	sf	i		Versione motore Motor version		
350							350								
(3000 min ⁻¹)	30.0	74	1.7	100	ECMM 250/030/063	120/240	(3000 min ⁻¹)	6.0	286	4.5	500	ECMM 250/050/110	120/240		
	20.0	103	1.7	150		120.66/240.66		5.0	361	2.9	600		120.66/240.66		
	15.0	129	1.7	200				4.0	441	2.2	750				
	12.0	152	1.5	250				3.3	503	2.6	900				
	10.0	173	1.7	300				2.5	639	2.3	1200				
	7.5	208	1.2	400				2.00	763	1.4	1500				
	6.0	241	1.0	500				1.67	877	1.1	1800				
	5.0	327	0.8	600				1.25	1115	1.1	2400				
	4.0	393	0.7	750				1.00	1325	1.0	3000				
	3.3	448	0.7	900											
	2.5	260	1.0	1200											
	2.00	310	1.0	1500											
	15.0	133	2.9	200		ECMM 250/040/070	120/240	(3000 min ⁻¹)	40.0	78	1.1		75	ECMM 350/030/040	120/240
	12.0	158	2.2	250			120.66/240.66		30.0	101	0.8		100		120.66/240.66
	10.0	175	2.6	300					20.0	87	1.0		150		
	7.5	210	1.8	400				15.0	74	1.0	200				
	6.0	244	1.4	500				12.0	67	1.0	250				
	5.0	335	1.4	600				10.0	90	1.0	300				
	4.0	403	1.1	750				7.5	74	1.0	400				
	3.3	466	1.0	900				40.0	79	1.4	75	ECMM 350/030/050	120/240		
	2.5	379	1.0	1200				30.0	103	1.2	100		120.66/240.66		
	2.00	453	1.0	1500				20.0	146	1.1	150				
	1.67	453	1.0	1800				15.0	184	0.7	200				
	1.25	379	1.0	2400				12.0	216	0.6	250				
	1.00	336	1.0	3000				10.0	235	0.7	300				
	15.0	134	3.5	200	ECMM 250/040/075		120/240	7.5	135	1.0	400				
	12.0	158	2.6	250			120.66/240.66		6.0	125	1.0		500		
	10.0	175	3.1	300				5.0	162	1.0	600				
	7.5	214	2.2	400				4.0	162	1.0	750				
	6.0	244	1.7	500				3.3	162	1.0	900				
	5.0	335	1.6	600				40.0	80	1.4	75		ECMM 350/030/063	120/240	
	4.0	403	1.4	750				30.0	104	1.2	100			120.66/240.66	
	3.3	466	1.2	900				20.0	144	1.2	150				
	2.5	569	0.8	1200				15.0	181	1.2	200				
	2.00	696	0.8	1500				12.0	213	1.1	250				
	1.67	547	1.0	1800				10.0	243	1.2	300				
	1.25	470	1.0	2400				7.5	292	0.9	400				
	1.00	403	1.0	3000				6.0	338	0.7	500				
	12.0	168	3.4	250		ECMM 250/040/090	120/240	5.0	458	0.7	600				
	10.0	184	3.4	300			120.66/240.66		4.0	310	1.0	750			
	7.5	226	3.4	400				3.3	310	1.0	900				
	6.0	263	2.6	500				2.5	260	1.0	1200				
	5.0	351	1.7	600				2.0	310	1.0	1500				
	4.0	423	1.3	750											
	3.3	489	1.5	900											
	2.5	600	0.8	1200											
	2.00	730	0.7	1500											
	1.67	838	0.7	1800											
	1.25	1029	0.8	2400											
	1.00	689	1.0	3000											

N.B.
Verificare sempre che la coppia M2 utilizzata non ecceda il valore indicato nelle caselle in grigio
N.B.
Please check that the output torque M2 does not exceed the value in the grey areas



NOTA: per servizio continuo o altamente intermittente, contattare il servizio tecnico

NOTE: for continuous or highly intermittent duty, please contact our technical service



Dati tecnici per servizio S2

Technical data for S2 duty

P_1 [W]	n_2 [min ⁻¹]	M_2 [Nm]	sf	i		Versione motore Motor version	P_1 [W]	n_2 [min ⁻¹]	M_2 [Nm]	sf	i		Versione motore Motor version			
500							800									
(3000 min ⁻¹)	20.0	148	2.4	150	ECMM 350/040/070	120/240	(3000 min ⁻¹)	40.0	132	1.8	75	ECMM 600/040/070	120/240			
	15.0	186	2.1	200		120.66/240.66		30.0	172	1.5	100		120.66/240.66			
	12.0	222	1.5	250				20.0	239	1.5	150					
	10.0	246	1.8	300				15.0	301	1.3	200					
	7.5	295	1.3	400				12.0	359	0.9	250					
	6.0	341	1.0	500				10.0	398	1.1	300					
	5.0	469	1.0	600				7.5	477	0.8	400					
	4.0	565	0.8	750				6.0	336	1.0	500					
	3.3	653	0.7	900				5.0	453	1.0	600					
	2.5	379	1.0	1200				4.0	453	1.0	750					
	2.00	453	1.0	1500				3.3	453	1.0	900					
	1.67	453	1.0	1800				2.5	379	1.0	1200					
	1.25	379	1.0	2400												
	20.0	150	2.4	150		ECMM 350/040/075	120/240		40.0	132	1.8		75	ECMM 600/040/075	120/240	
	15.0	188	2.4	200			120.66/240.66		30.0	172	1.5		100		120.66/240.66	
	12.0	222	1.8	250					20.0	242	1.5		150			
	10.0	246	2.2	300					15.0	305	1.5		200			
	7.5	300	1.6	400					12.0	359	1.1		250			
	6.0	341	1.2	500					10.0	398	1.4		300			
	5.0	469	1.2	600					7.5	486	1.0		400			
	4.0	565	0.9	750				6.0	403	1.0	500					
	3.3	653	0.8	900				5.0	547	1.0	600					
	2.5	470	1.0	1200				4.0	547	1.0	750					
	2.0	547	1.0	1500				3.3	547	1.0	900					
	1.7	547	1.0	1800				2.5	470	1.0	1200					
	1.3	470	1.0	2400												
	12.0	236	2.4	250	ECMM 350/040/090	120/240		20.0	249	1.5	150	ECMM 600/040/090	120/240			
	10.0	258	2.4	300		120.66/240.66		15.0	318	1.5	200		120.66/240.66			
	7.5	317	2.4	400				12.0	381	1.5	250					
	6.0	369	1.9	500				10.0	418	1.5	300					
	5.0	493	1.2	600				7.5	513	1.5	400					
	4.0	593	0.9	750				6.0	597	1.2	500					
	3.3	685	1.0	900				5.0	797	1.2	600					
	2.5	841	1.0	1200				2.5	813	1.0	1200					
	2.0	1024	0.9	1500												
	1.7	1175	0.8	1800												
	1.3	813	1.0	2400												
	1.0	689	1.0	3000												
	6.0	401	3.2	500	ECMM 350/050/110	120/240		12.0	402	2.7	250	ECMM 600/050/110	120/240			
	5.0	506	2.1	600		120.66/240.66		10.0	429	2.7	300		120.66/240.66			
	4.0	618	1.6	750				7.5	545	2.6	400					
	3.3	705	1.8	900				6.0	648	2.0	500					
	2.5	896	1.6	1200				5.0	819	1.3	600					
	2.0	1070	1.0	1500				4.0	1000	1.0	750					
	1.7	1230	0.8	1800				3.3	1141	1.1	900					
	1.3	1563	0.8	2400				2.5	1450	1.0	1200					
	1.0	1272	1.0	3000				2.0	1731	0.9	1500					
								1.7	1990	0.8	1800					
								1.3	1443	1.0	2400					
								1.0	1272	1.0	3000					
	4.0	645	2.6	750	ECMM 350/063/130	120/240		7.5	563	2.8	400	ECMM 600/063/130	120/240			
	3.3	737	2.3	900		IEC 71B14		6.0	682	2.2	500		120.66/240.66			
	2.5	938	1.7	1200				5.0	845	2.0	600					
	2.0	1135	1.5	1500		Solo / Only		4.0	1044	1.6	750					
	1.7	1306	1.3	1800				3.3	1192	1.4	900					
	1.3	1662	1.0	2400				2.5	1517	1.1	1200					
	1.0	2011	0.7	3000				2.0	1836	0.9	1500					
								1.7	2112	0.8	1800					
								1.3	1600	1.0	2400					
								1.0	1500	1.0	3000					

N.B.
Verificare sempre che la coppia M2 utilizzata non ecceda il valore indicato nelle caselle in grigio
N.B.
Please check that the output torque M2 does not exceed the value in the grey areas

NOTA: per servizio continuo o altamente intermittente, contattare il servizio tecnico

NOTE: for continuous or highly intermittent duty, please contact our technical service



Motori applicabili

Motor adapters

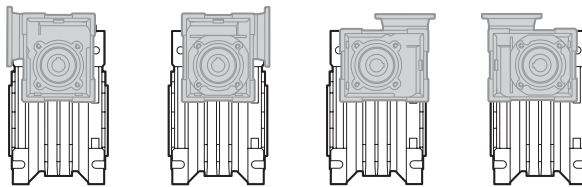

US1

US2

UV1

UV2

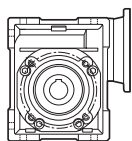
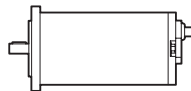

		EC			
		070.12E 070.24E	100.120 100.240	100.24E	180.120 180.240
CMM	026/026	150 - 3600	150 - 3600	150 - 3600	150 - 3600

150 - 3600

Rapporti di riduzione i
Ratio i

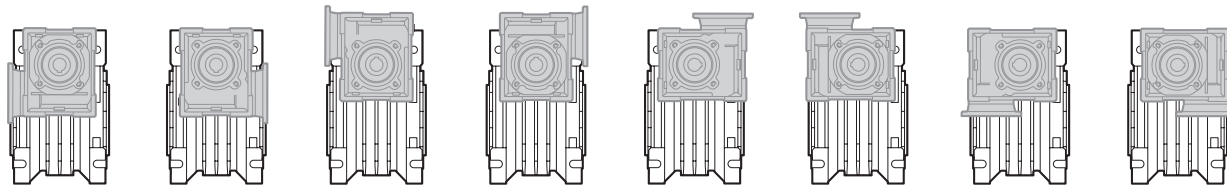

UB1

UB2

US1

US2

UV1

UV2

UC1

UC2

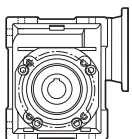

		EC							
		070.12E 070.24E	100.120 100.240	100.24E	180.120 180.240	180.24E	250.120 250.240	350.120 350.240	600.120 600.240
CMM	026/030	150 - 3600	150 - 3600	150 - 3600	150 - 3600				
	026/040	150 - 3600	150 - 3600	150 - 3600	150 - 3600				
	026/050	150 - 3600	150 - 3600	150 - 3600	150 - 3600				
	030/040	75 - 3000	75 - 3000	75 - 3000	75 - 3000	75 - 1500	75 - 1500	75 - 1500	
	030/050	75 - 3000	75 - 3000	75 - 3000	75 - 3000	75 - 1500	75 - 1500	75 - 1500	
	030/063	75 - 3000	75 - 3000	75 - 3000	75 - 3000	75 - 1500	75 - 1500	75 - 1500	
	040/070	75 - 3000	75 - 3000	75 - 3000	75 - 3000	75 - 3000	75 - 3000	75 - 3000	75 - 1200
	040/075	75 - 3000	75 - 3000	75 - 3000	75 - 3000	75 - 3000	75 - 3000	75 - 3000	75 - 1200
	040/090	75 - 3000	75 - 3000	75 - 3000	75 - 3000	75 - 3000	75 - 3000	75 - 3000	75 - 1200
	050/110				1200 - 3000 ⁽¹⁾	75 - 3000	75 - 3000	75 - 3000	75 - 3000
063/130							75 - 3000 ⁽²⁾	75 - 3000	

150 - 3600

Rapporti di riduzione i
Ratio i

(1): Solo IEC 63 B14
63 B14 only

(2): Solo IEC 71 B14
71 B14 only



Dimensioni

Dimensions

CMM..U - CMM..F..																	
	A	C	D _{H8}	E	F	G	G1	H	H1	I	I1	K	L	M	N _{h8}	N1	N2
026/026 (D11)	45	70	11	83	22	47.5	50	35	34	26	26	34	42	55	45	22.5	21
026/026			12														
026/026 (D14)			14														
026/030	54	80	14	97	32	47.5	63	40	34	30	26	44	56	65	55	29	21
026/040	70	100	18	121.5	43	47.5	78	50	34	40	26	60	71	75	60	36.5	21
026/050	80	120	25	144	49	47.5	92	60	34	50	26	70	85	85	70	43.5	21
030/040	70	100	18	121.5	43	55	78	50	40	40	30	60	71	75	60	36.5	29
030/050	80	120	25	144	49	55	92	60	40	50	30	70	85	85	70	43.5	29
030/063	100	144	25	174	67	55	112	72	40	63	30	85	104	95	80	53	29
040/070	110	160	28	195	64	70	120	80	50	70	40	90	104	115	95	57	35.5
040/075	120	172	28	205	72	70	120	86	50	75	40	90	112	115	95	57	36.5
040/090	140	208	35	238	74	70	140	103	50	90	40	100	130	130	110	67	36.5

CMM..U - CMM..F..														
	O	P	Q	R	R1	S	T	V	Z	KE	a	b	t	Kg (!)
026/026 (D11)	6	—	37	49	49	5	15	21	76	7	—	4	12.8	3.3
026/026												4	13.8	
026/026 (D14)												5	16.2	
026/030	6.5	75	44	57	49	5.5	22	27	81	M6x10(n.4)	90°	5	16.3	4.1
026/040	6.5	87	55	71.5	49	6.5	26	35	91.5	M6x8(n.4)	45°	6	20.8	5.2
026/050	8.5	98	64	84	49	7	30	40	100.5	M8x10(n.4)	45°	8	28.3	6.7
030/040	6.5	87	55	71.5	57	6.5	26	35	122	M6x8(n.4)	45°	6	20.8	5.6
030/050	8.5	98	64	84	57	7	30	40	132	M8x10(n.4)	45°	8	28.3	6.7
030/063	8.5	110	80	102	57	8	36	50	145	M8x14(n.8)	45°	8	28.3	8.7
040/070	9	130	91	115	71.5	9	40	55	160	M8x14(n.8)	45°	8	31.3	12.7
040/075	11	140	93	119	71.5	10	40	60	165	M8x14(n.8)	45°	8	31.3	13.7
040/090	13	160	102	135	71.5	11	45	70	182	M10x18(n.8)	45°	10	38.3	17.3

(!) **Nota:** Il peso in kg si riferisce al motoriduttore ECMM 070 /...
Note: The weight in kg is referred to the gearmotor ECMM 070 /...

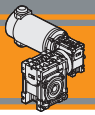

Dimensioni

Dimensions

ECMM070/...U

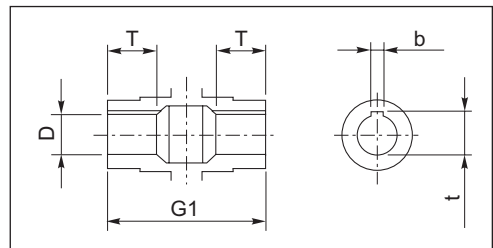
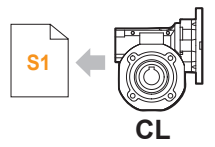
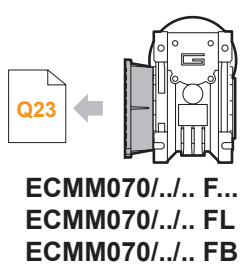
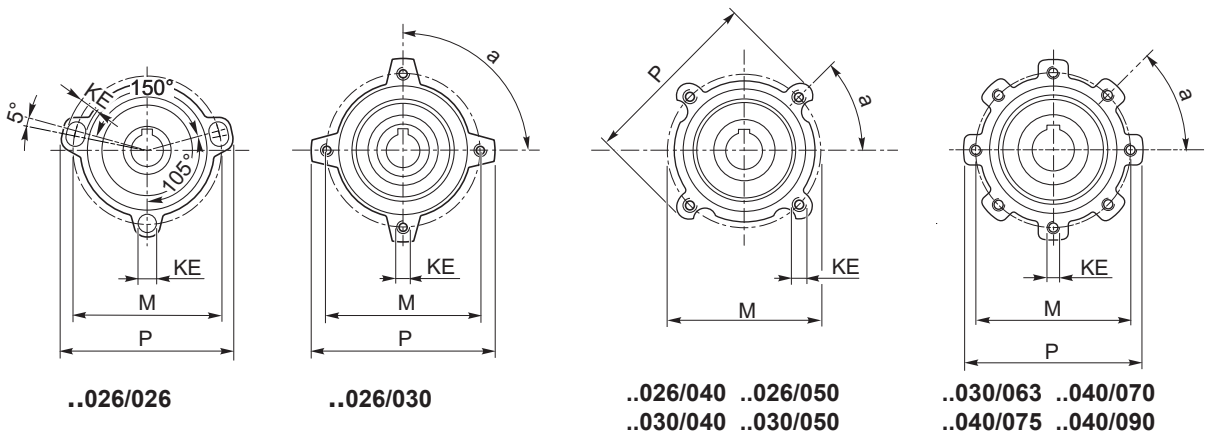
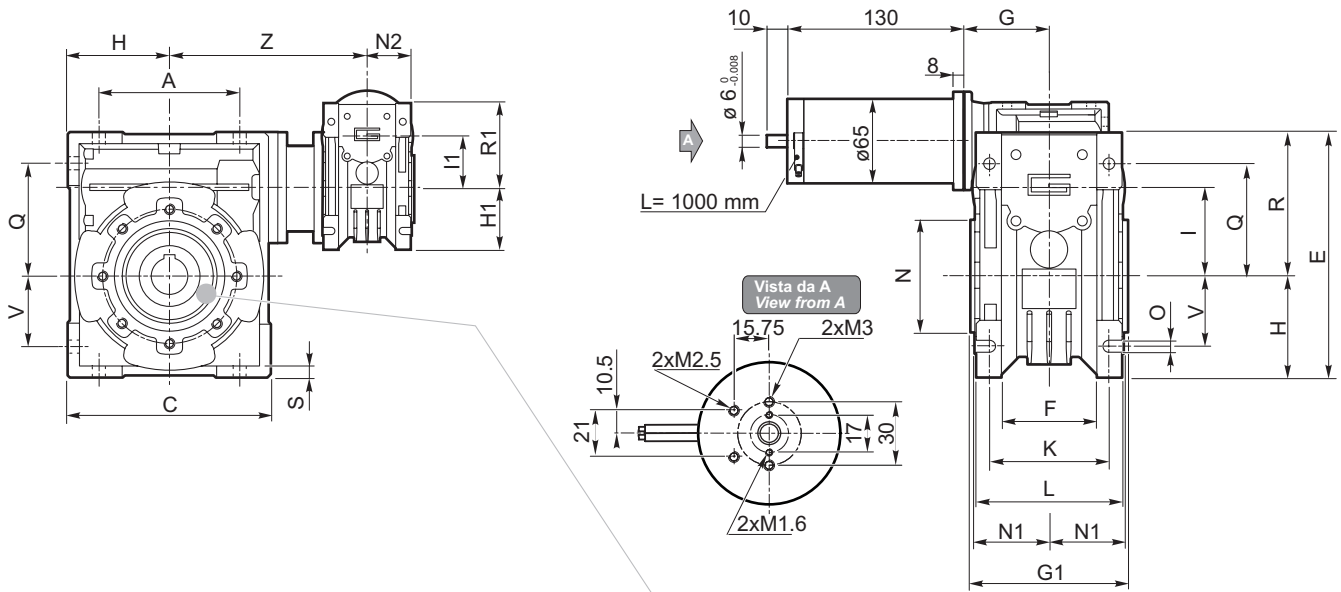

Albero lento cavo / Hollow output shaft

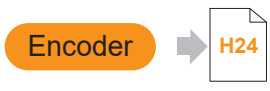



Dimensioni

Dimensions

CMM..U - CMM..F...																	
	A	C	D _{H8}	E	F	G	G1	H	H1	I	I1	K	L	M	N _{H8}	N1	N2
026/026 (D11)	45	70	11	83	22	47.5	50	35	34	26	26	34	42	55	45	22.5	21
026/026			12														
026/026 (D14)			14														
026/030	54	80	14	97	32	47.5	63	40	34	30	26	44	56	65	55	29	21
026/040	70	100	18	121.5	43	47.5	78	50	34	40	26	60	71	75	60	36.5	21
026/050	80	120	25	144	49	47.5	92	60	34	50	26	70	85	85	70	43.5	21
030/040	70	100	18	121.5	43	55	78	50	40	40	30	60	71	75	60	36.5	29
030/050	80	120	25	144	49	55	92	60	40	50	30	70	85	85	70	43.5	29
030/063	100	144	25	174	67	55	112	72	40	63	30	85	104	95	80	53	29
040/070 *	110	160	28	195	64	70	120	80	50	70	40	90	104	115	95	57	35.5
040/075 *	120	172	28	205	72	70	120	86	50	75	40	90	112	115	95	57	36.5
040/090 *	140	208	35	238	74	70	140	103	50	90	40	100	130	130	110	67	36.5

CMM..U - CMM..F...															
	O	P	Q	R	R1	S	T	V	Z	KE	a	b	t	Kg (!)	
026/026 (D11)	6	—	37	49	49	5	15	21	76	7	—	4	12.8	3.3	
026/026												4	13.8		
026/026 (D14)												5	16.2		
026/030	6.5	75	44	57	49	5.5	22	27	81	M6x10(n.4)	90°	5	16.3	5.1	
026/040	6.5	87	55	71.5	49	6.5	26	35	91.5	M6x8(n.4)	45°	6	20.8	6.2	
026/050	8.5	98	64	84	49	7	30	40	100.5	M8x10(n.4)	45°	8	28.3	7.7	
030/040	6.5	87	55	71.5	57	6.5	26	35	122	M6x8(n.4)	45°	6	20.8	6.6	
030/050	8.5	98	64	84	57	7	30	40	132	M8x10(n.4)	45°	8	28.3	7.7	
030/063	8.5	110	80	102	57	8	36	50	145	M8x14(n.8)	45°	8	28.3	9.7	
040/070 *	9	130	91	115	71.5	9	40	55	160	M8x14(n.8)	45°	8	31.3	13.7	
040/075 *	11	140	93	119	71.5	10	40	60	165	M8x14(n.8)	45°	8	31.3	14.7	
040/090 *	13	160	102	135	71.5	11	45	70	182	M10x18(n.8)	45°	10	38.3	18.3	

(!) **Nota:** Il peso in kg si riferisce al motoriduttore ECMM 100 /...
Note: The weight in kg is referred to the gearmotor ECMM 100 /...

*: Motore inclinato con portaspazzole a 45°
Motor assembly with brush holder inclined 45°



Dimensioni

Dimensions

ECMM100/...U

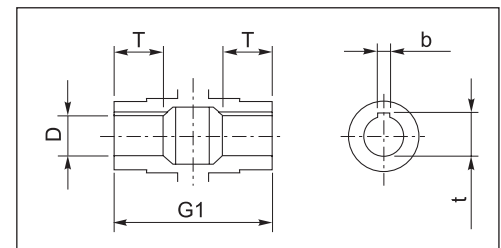
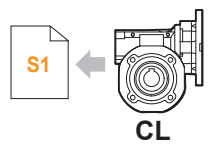
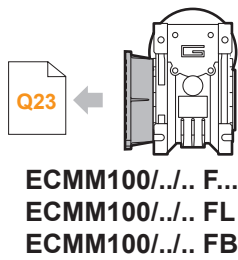
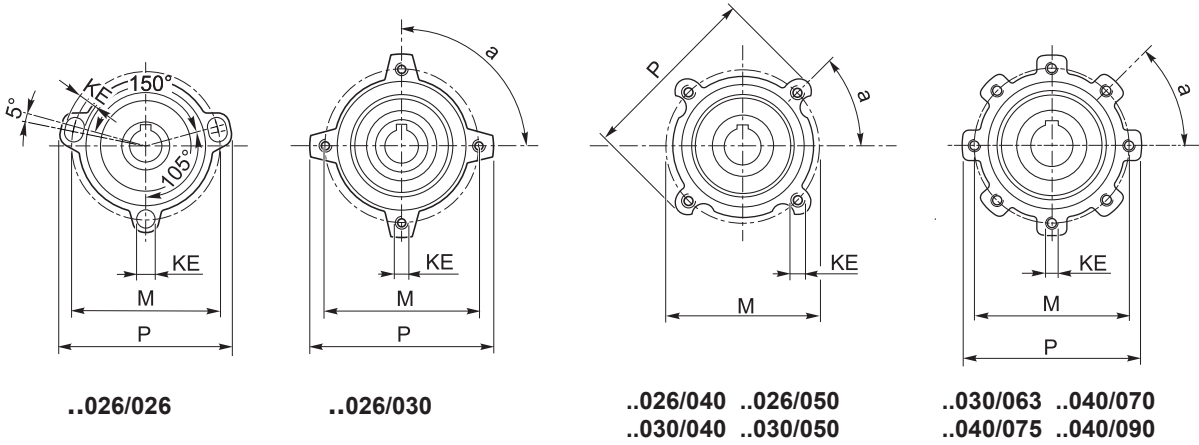
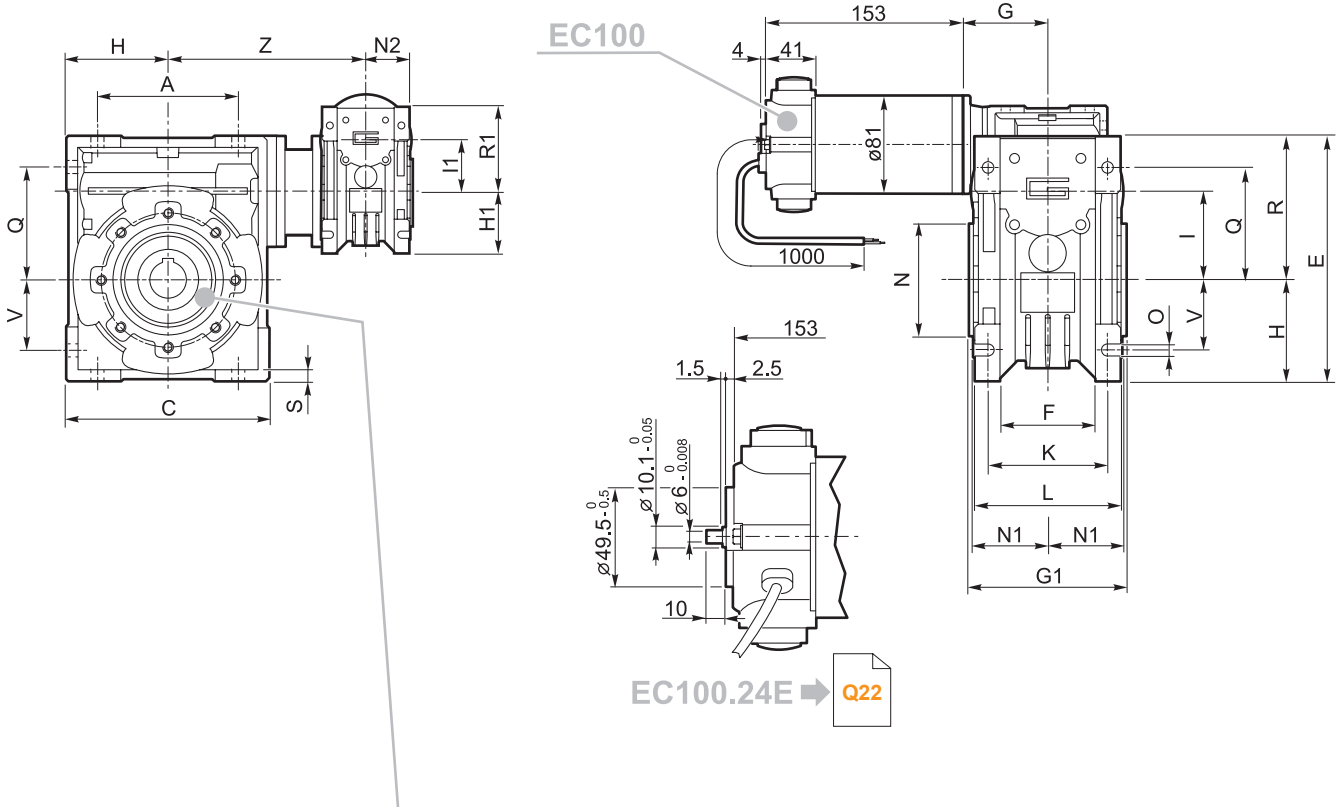

Albero lento cavo / Hollow output shaft

Motori / Motors IP66 → **I4**

Freno / Brake → **H23**

Encoder → **H24**

ECMM

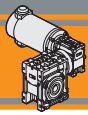

Dimensioni

Dimensions

CMM..U - CMM..F - CMM..FB - CMM..FL																	
	A	C	D _{H8}	E	F	G	G1	H	H1	I	I1	K	L	M	N _{H8}	N1	N2
026/040 ⁽¹⁾	70	100	18	121.5	43	47.5	78	50	34	40	26	60	71	75	60	36.5	21
026/050 ⁽¹⁾	80	120	25	144	49	47.5	92	60	34	50	26	70	85	85	70	43.5	21
030/040	70	100	18	121.5	43	55	78	50	40	40	30	60	71	75	60	36.5	29
030/050	80	120	25	144	49	55	92	60	40	50	30	70	85	85	70	43.5	29
030/063	100	144	25	174	67	55	112	72	40	63	30	85	104	95	80	53	29
040/070 *	110	160	28	195	64	70	120	80	50	70	40	90	104	115	95	57	35.5
040/075 *	120	172	28	205	72	70	120	86	50	75	40	90	112	115	95	57	36.5
040/090 *	140	208	35	238	74	70	140	103	50	90	40	100	130	130	110	67	36.5
050/110 ⁽²⁾	170	252.5	42	295	—	80	155	127.5	60	110	50	115	144	165	130	74	43.5

CMM..U - CMM..F - CMM..FB - CMM..FL														
	O	P	Q	R	R1	S	T	V	Z	KE	a	b	t	Kg (!)
026/040 ⁽¹⁾	6.5	87	55	71.5	49	6.5	26	35	91.5	M6x8(n.4)	45°	6	20.8	6.9
026/050 ⁽¹⁾	8.5	98	64	84	49	7	30	40	100.5	M8x10(n.4)	45°	8	28.3	8.4
030/040	6.5	87	55	71.5	57	6.5	26	35	122	M6x8(n.4)	45°	6	20.8	7.3
030/050	8.5	98	64	84	57	7	30	40	132	M8x10(n.4)	45°	8	28.3	8.4
030/063	8.5	110	80	102	57	8	36	50	145	M8x14(n.8)	45°	8	28.3	10.4
040/070 *	9	130	91	115	71.5	9	40	55	160	M8x14(n.8)	45°	8	31.3	14.4
040/075 *	11	140	93	119	71.5	10	40	60	165	M8x14(n.8)	45°	8	31.3	15.4
040/090 *	13	160	102	135	71.5	11	45	70	182	M10x18(n.8)	45°	10	38.3	19
050/110 ⁽²⁾	14	200	125	167.5	84	14	50	85	225	M10x18(n.8)	45°	12	45.3	33.6

(!) **Nota:** Il peso in kg si riferisce al motoriduttore ECMM 180 /...
Note: The weight in kg is referred to the gearmotor ECMM 180 /...

*: Motore inclinato con portaspazzole a 45°
Motor assembly with brush holder inclined 45°

(1): Versione 24E non disponibile
Version 24E not available

(2): Solo IEC 63 B14. Versione IP66 non disponibile
IEC 63 B14 only. IP66 version not available



Dimensioni

Dimensions

ECMM180/.../..U

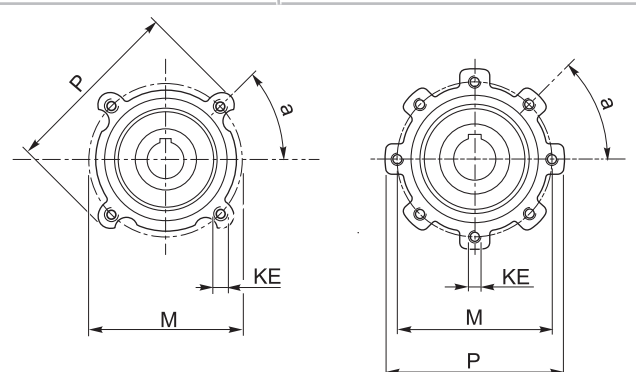
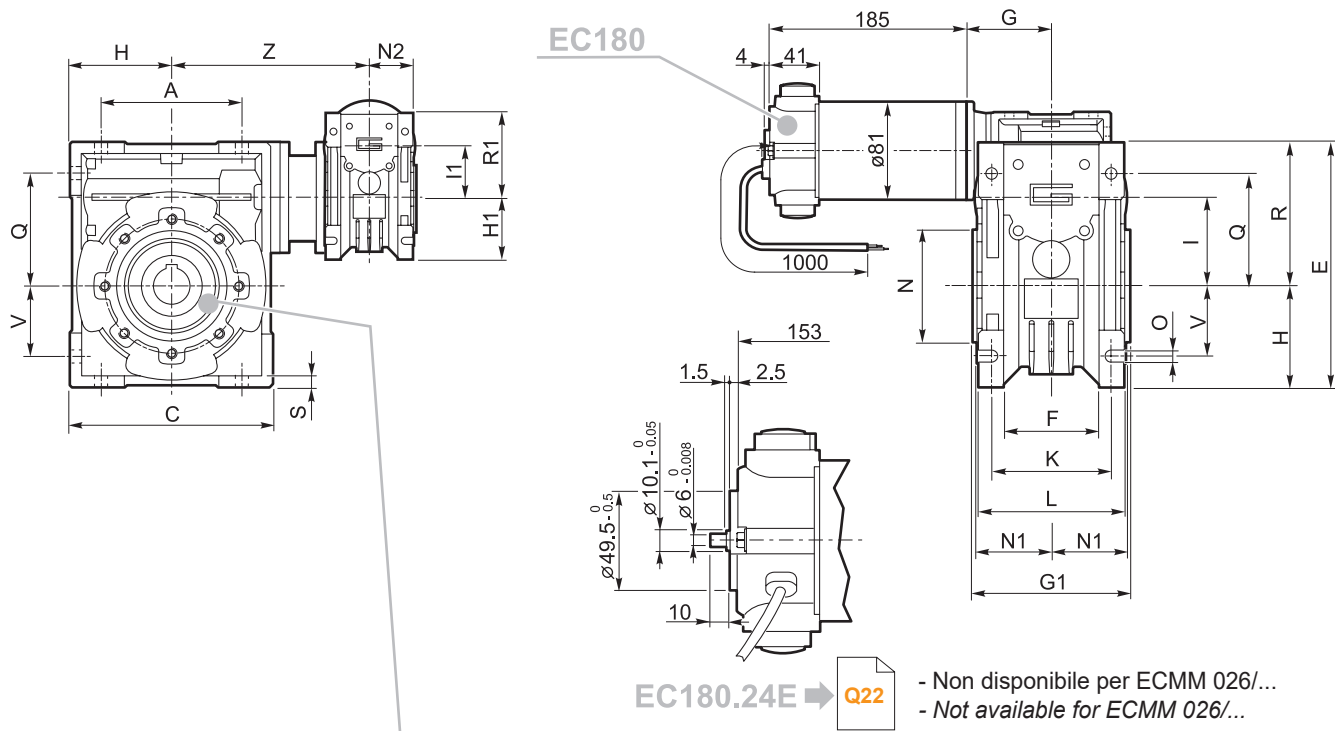

- | | | | |
|-----------|-----------|-----------|-----------|
| ..026/040 | ..026/050 | ..030/063 | ..040/070 |
| ..030/040 | ..030/050 | ..040/075 | ..040/090 |
| | | ..050/110 | |

Q23 →

ECMM180/.../.. F
ECMM180/.../.. FL
ECMM180/.../.. FB

S1 →

CL

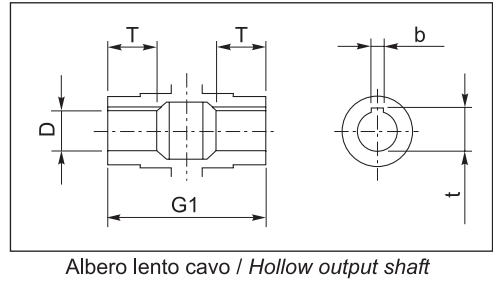

Motori / Motors IP66 → **I6**

- Non disponibile per ECMM 180/050/110
- Not available for ECMM 180/050/110

Freno / Brake → **H23**

Encoder → **H24**



Dimensioni

Dimensions

CMM..U - CMM..F - CMM..FB - CMM..FL																	
	A	C	D _{H8}	E	F	G	G1	H	H1	I	I1	K	L	M	N _{H8}	N1	N2
030/040	70	100	18	121.5	43	55	78	50	40	40	30	60	71	75	60	36.5	29
030/050	80	120	25	144	49	55	92	60	40	50	30	70	85	85	70	43.5	29
030/063	100	144	25	174	67	55	112	72	40	63	30	85	104	95	80	53	29
040/070	110	160	28	195	64	70	120	80	50	70	40	90	104	115	95	57	35.5
040/075	120	172	28	205	72	70	120	86	50	75	40	90	112	115	95	57	36.5
040/090	140	208	35	238	74	70	140	103	50	90	40	100	130	130	110	67	36.5
050/110	170	252.5	42	295	—	80	155	127.5	60	110	50	115	144	165	130	74	43.5

CMM..U - CMM..F - CMM..FB - CMM..FL														
	O	P	Q	R	R1	S	T	V	Z	KE	a	b	t	Kg (!)
030/040	6.5	87	55	71.5	57	6.5	26	35	122	M6x8(n.4)	45°	6	20.8	8.2
030/050	8.5	98	64	84	57	7	30	40	132	M8x10(n.4)	45°	8	28.3	9.3
030/063	8.5	110	80	102	57	8	36	50	145	M8x14(n.8)	45°	8	28.3	11.3
040/070	9	130	91	115	71.5	9	40	55	160	M8x14(n.8)	45°	8	31.3	15.3
040/075	11	140	93	119	71.5	10	40	60	165	M8x14(n.8)	45°	8	31.3	16.3
040/090	13	160	102	135	71.5	11	45	70	182	M10x18(n.8)	45°	10	38.3	19.9
050/110	14	200	125	167.5	84	14	50	85	225	M10x18(n.8)	45°	12	45.3	34.5

(!) **Nota:** Il peso in kg si riferisce al motoriduttore ECMM 250 /...
Note: The weight in kg is referred to the gearmotor ECMM 250 /...



Dimensioni

Dimensions

ECMM250/...U

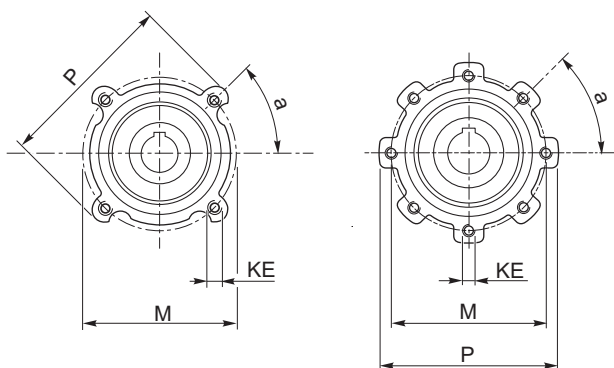
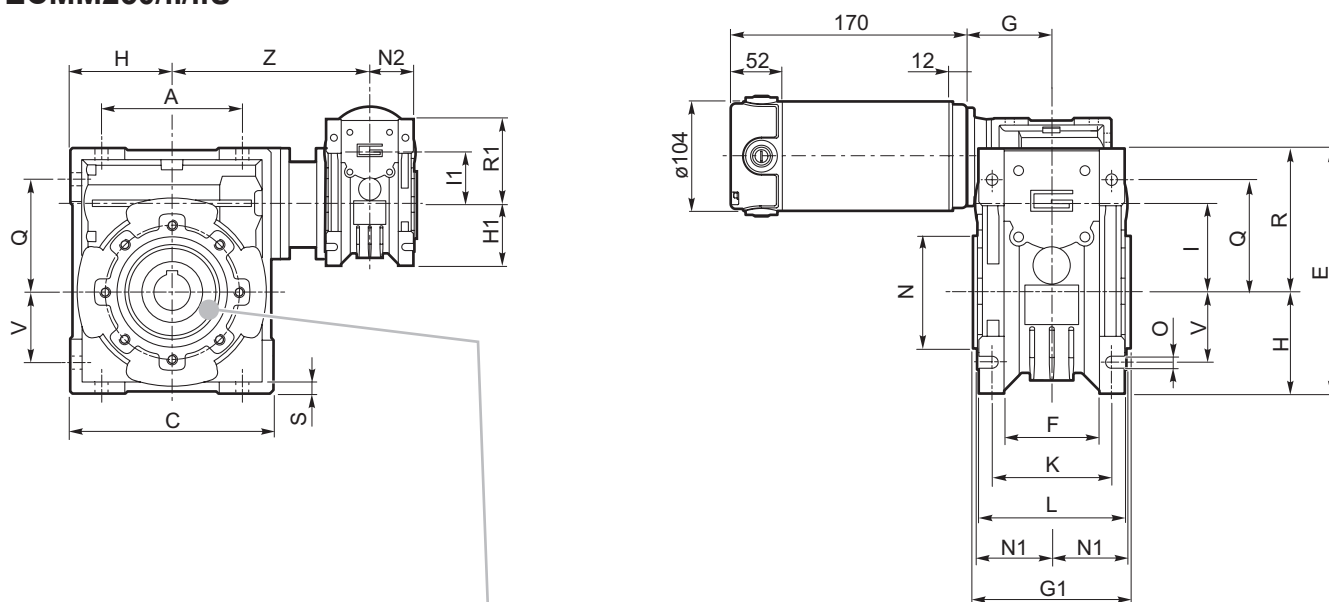

..030/040 ..030/050

..030/063 ..040/070
..040/075 ..040/090
..050/110

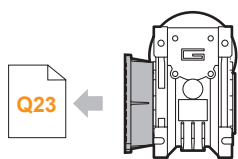

ECMM250/... F
ECMM250/... FL
ECMM250/... FB

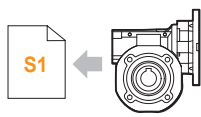

CL

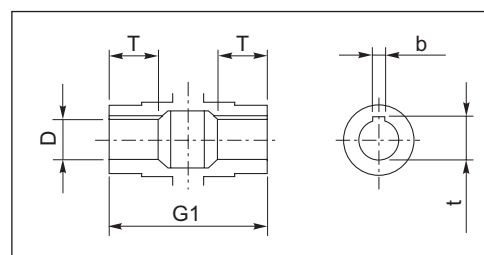

Albero lento cavo / Hollow output shaft

Motori / Motors IP66



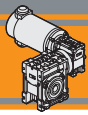

Dimensioni

Dimensions

CMM..U - CMM..F - CMM..FB - CMM..FL																	
	A	C	D _{H8}	E	F	G	G1	H	H1	I	I1	K	L	M	N _{H8}	N1	N2
030/040	70	100	18	121.5	43	55	78	50	40	40	30	60	71	75	60	36.5	29
030/050	80	120	25	144	49	55	92	60	40	50	30	70	85	85	70	43.5	29
030/063	100	144	25	174	67	55	112	72	40	63	30	85	104	95	80	53	29
040/070	110	160	28	195	64	70	120	80	50	70	40	90	104	115	95	57	35.5
040/075	120	172	28	205	72	70	120	86	50	75	40	90	112	115	95	57	36.5
040/090	140	208	35	238	74	70	140	103	50	90	40	100	130	130	110	67	36.5
050/110	170	252.5	42	295	—	80	155	127.5	60	110	50	115	144	165	130	74	43.5
063/130 ⁽¹⁾	200	292.5	45	335	—	95	170	147.5	72	130	63	120	155	215	180	81	53

CMM..U - CMM..F - CMM..FB - CMM..FL														
	O	P	Q	R	R1	S	T	V	Z	KE	a	b	t	Kg (!)
030/040	6.5	87	55	71.5	57	6.5	26	35	122	M6x8(n.4)	45°	6	20.8	9.2
030/050	8.5	98	64	84	57	7	30	40	132	M8x10(n.4)	45°	8	28.3	10.3
030/063	8.5	110	80	102	57	8	36	50	145	M8x10(n.8)	45°	8	28.3	12.3
040/070	9	130	91	115	71.5	9	40	55	160	M8x14(n.8)	45°	8	31.3	16.3
040/075	11	140	93	119	71.5	10	40	60	165	M8x14(n.8)	45°	8	31.3	17.3
040/090	13	160	102	135	71.5	11	45	70	182	M10x18(n.8)	45°	10	38.3	20.9
050/110	14	200	125	167.5	84	14	50	85	225	M10x18(n.8)	45°	12	45.3	35.5
063/130 ⁽¹⁾	16	250	140	187.5	102	15	60	100	245	M12x21(n.8)	45°	14	48.8	60.3

(!) **Nota:** Il peso in kg si riferisce al motoriduttore ECMM 350 /...
Note: The weight in kg is referred to the gearmotor ECMM 350 /...

(1): Solo IEC 71 B14. Versione IP66 non disponibile
IEC 71 B14 only. IP66 version not available

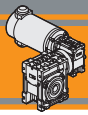
**Dimensioni****Dimensions**

CMM..U - CMM..F - CMM..FB - CMM..FL																	
	A	C	D _{H8}	E	F	G	G1	H	H1	I	I1	K	L	M	N _{H8}	N1	N2
040/070	110	160	28	195	64	70	120	80	50	70	40	90	104	115	95	57	35.5
040/075	120	172	28	205	72	70	120	86	50	75	40	90	112	115	95	57	36.5
040/090	140	208	35	238	74	70	140	103	50	90	40	100	130	130	110	67	36.5
050/110	170	252.5	42	295	—	80	155	127.5	60	110	50	115	144	165	130	74	43.5
063/130	200	292.5	45	335	—	95	170	147.5	72	130	63	120	155	215	180	81	53

CMM..U - CMM..F - CMM..FB - CMM..FL															
	O	P	Q	R	R1	S	T	V	Z	KE	a	b	t	Kg (!)	
040/070	9	130	91	115	71.5	9	40	55	160	M8x14(n.8)	45°	8	31.3	18.3	
040/075	11	140	93	119	71.5	10	40	60	165	M8x14(n.8)	45°	8	31.3	19.3	
040/090	13	160	102	135	71.5	11	45	70	182	M10x18(n.8)	45°	10	38.3	22.7	
050/110	14	200	125	167.5	84	14	50	85	225	M10x18(n.8)	45°	12	45.3	37.3	
063/130	16	250	140	187.5	102	15	60	100	245	M12x21(n.8)	45°	14	48.8	62.1	

(!) **Nota:** Il peso in kg si riferisce al motoriduttore ECMM 600 /...

Note: The weight in kg is referred to the gearmotor ECMM 600 /...



Dimensioni

Dimensions

ECMM600/...U

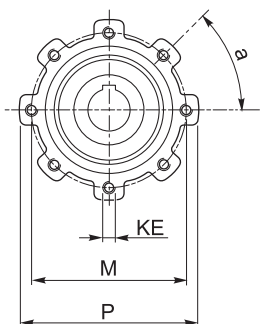
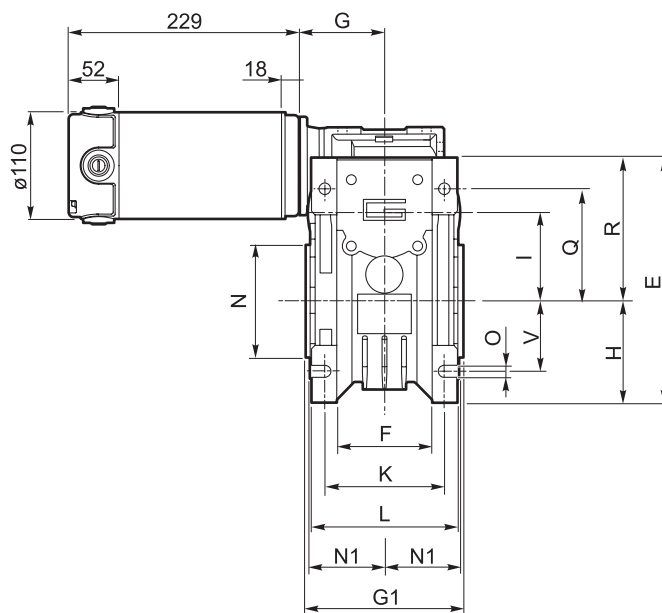
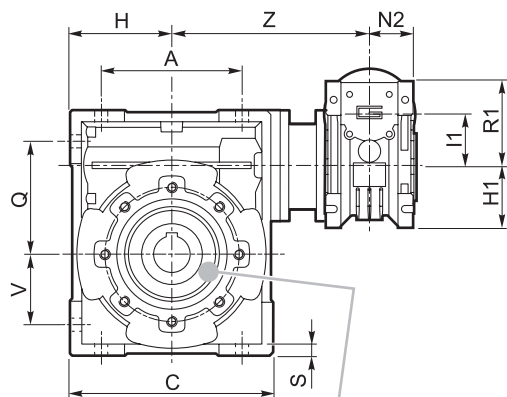

..040/070 ..040/075
..040/090 ..050/110
..063/130

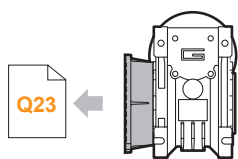

ECMM600/... F
ECMM600/... FL
ECMM600/... FB

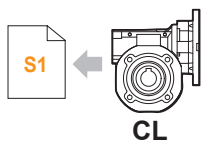

CL

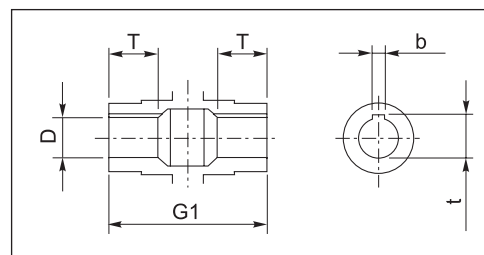

Albero lento cavo / Hollow output shaft

Motori / Motors IP66

→ **I12**

Freno / Brake

→ **H23**

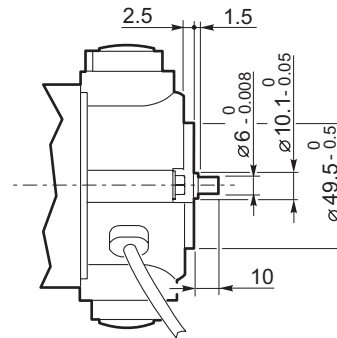
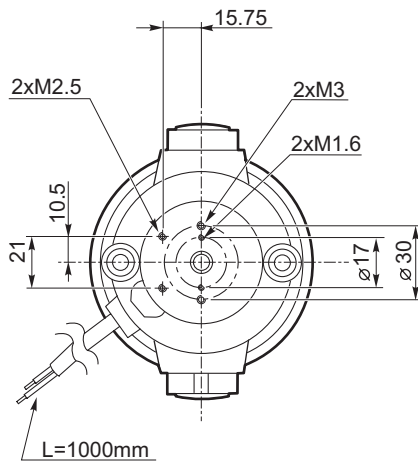
**Dimensioni****Dimensions****EC100.24E**
EC180.24E

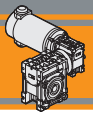

Dimensioni

Dimensions

ECMM.../... F... Flange uscita / Output flanges

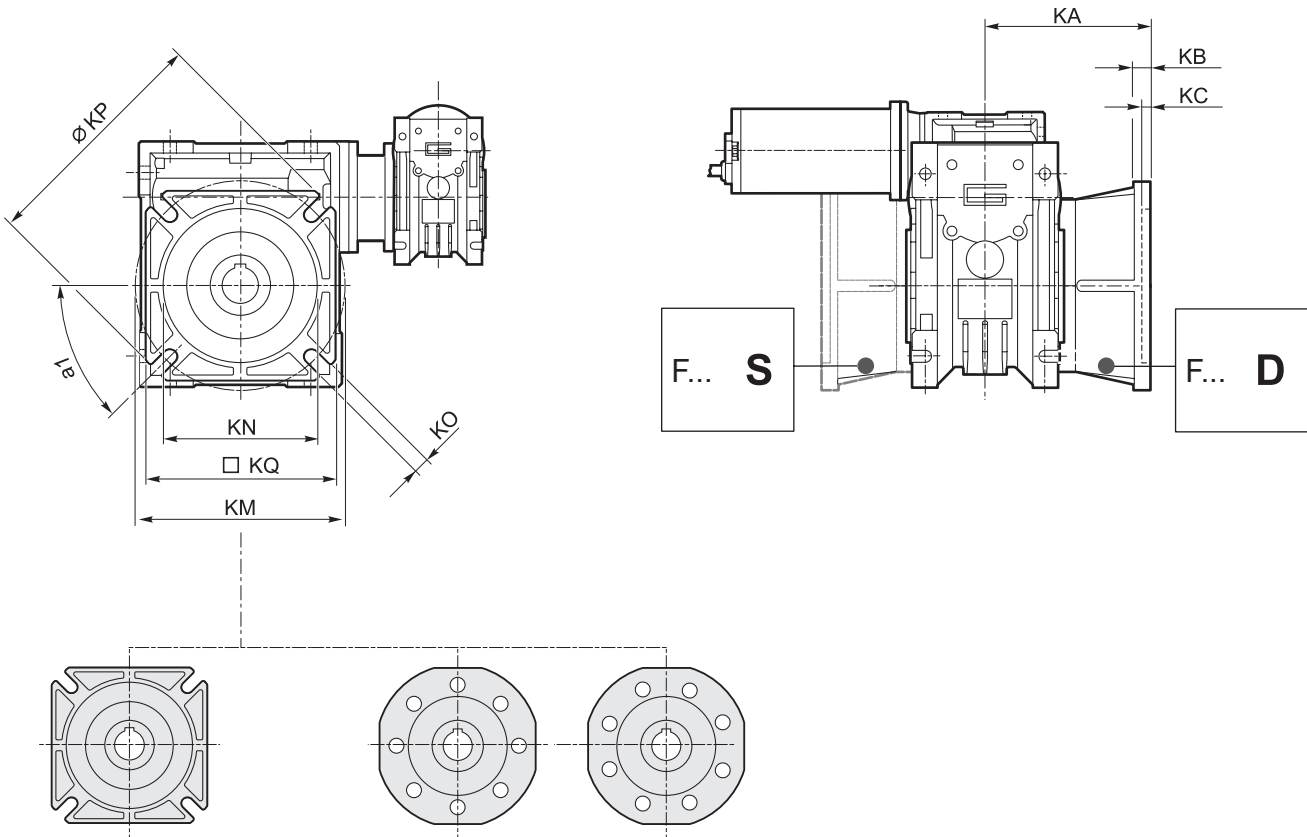

CMM..F...

(../026 - ../030 - ../040 - ../050
../063 - ../070 - ../075 - ../090)

CMM..F

(../110) (../130)

	CMM..F								CMM..F28						CMM..F30										
	a1	KA	KB	KC	KM	KN _{H8}	KO	KP	KQ	KA	KB	KC	KM	KN _{H8}	KO	KP	KQ	KA	KB	KC	KM	KN _{H8}	KO	KP	KQ
026/026 (D11)	45°	45	6	4.5	55-69	40	6.5(n.4)	75	70	44	6.5	5	56-64	40	6.5	70	60	48	6.5	5	68	50	6.5	80	70
026/026																									
026/026 (D14)																									

	CMM..F								CMM..FB						CMM..FL										
	a1	KA	KB	KC	KM	KN _{H8}	KO	KP	KQ	KA	KB	KC	KM	KN _{H8}	KO	KP	KQ	KA	KB	KC	KM	KN _{H8}	KO	KP	KQ
026/030	45°	54.5	6	4	68	50	6.5(n.4)	80	70	—	—	—	—	—	—	—	—	—	—	—	—	—	—	—	—
026/040	45°	67	7.5	4.5	80-95	60	9(n.4)	110	95	80	8.5	5	115-125	95	9.5(n.4)	140	112	97	7.5	4.5	80-95	60	9(n.4)	110	95
030/040																									
026/050	45°	90	9	5	90-110	70	11(n.4)	125	110	89	9	5	130-145	110	9.5(n.4)	160	132	120	9	5	90-110	70	11(n.4)	125	110
030/050																									
040/063	45°	82	10	6	150-160	115	11(n.4)	180	142	98	10	5	165-180	130	11(n.4)	200	112	112	10	6	150-160	115	11(n.4)	180	142
040/070	45°	107	13	6	165-180	130	14(n.4)	200	170	—	—	—	—	—	—	—	—	—	—	—	—	—	—	—	—
040/075	45°	111	13	6	165-180	130	14(n.4)	200	170	—	—	—	—	—	—	—	—	—	—	—	—	—	—	—	—
040/090	45°	111	13	6	175-190	152	14(n.4)	210	200	—	—	—	—	—	—	—	—	—	—	—	—	—	—	—	—
050/110	45°	131	15	6	230	170	14(n.8)	280	260	—	—	—	—	—	—	—	—	—	—	—	—	—	—	—	—
063/130	22.5°	140	15	6	255	180	16(n.8)	320	290	—	—	—	—	—	—	—	—	—	—	—	—	—	—	—	—

ECMM

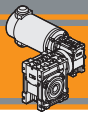

VS1 - VS2 - Vite sporgente / Extended input shaft

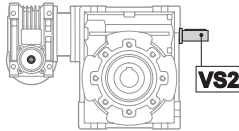
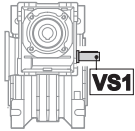
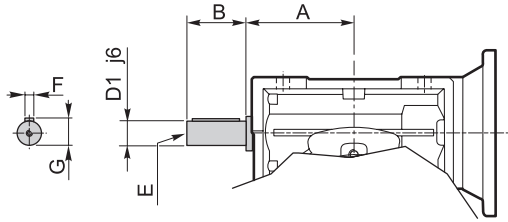

CMM	VS1						VS2					
	A	B	D ₁ j6	E	F	G	A	B	D ₁ j6	E	F	G
026/030	—	—	—	—	—	—	45	20	9	M4	3	10.2
026/040	—	—	—	—	—	—	53	23	11	M5	4	12.5
026/050	—	—	—	—	—	—	64	30	14	M6	5	16
030/040	45	20	9	M4	3	10.2	53	23	11	M5	4	12.5
030/050	45	20	9	M4	3	10.2	64	30	14	M6	5	16
030/063	45	20	9	M4	3	10.2	75	40	19	M6	6	21.5
040/070	53	23	11	M5	4	12.5	84	40	19	M6	6	21.5
040/075	53	23	11	M5	4	12.5	90	50	24	M8	8	27
040/090	53	23	11	M5	4	12.5	108	50	24	M8	8	27
050/110	64	30	14	M6	5	16	135	60	28	M10	8	31
063/130	75	40	19	M6	6	21.5	—	—	—	—	—	—

Costruito su richiesta
Built on request

SC - Safety cover

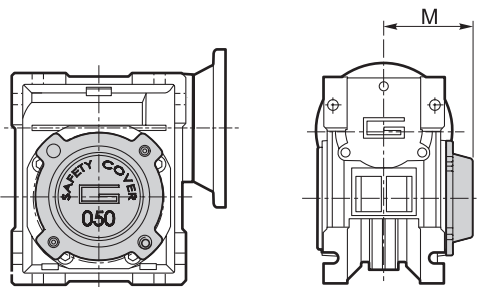

WD - Washdown cover

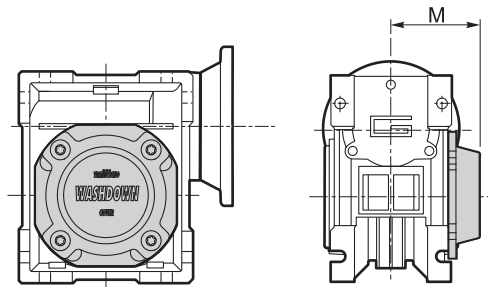

M	CM								
	30	40	50	63	70	75	90	110	130
M	47	54.5	62.5	73	79	79	94	102	117

M	CM							
	30	40	50	63	70	75	90	110
M	48	55.5	63.5	71.5	76	80	95	103

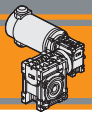

Albero lento semplice e doppio

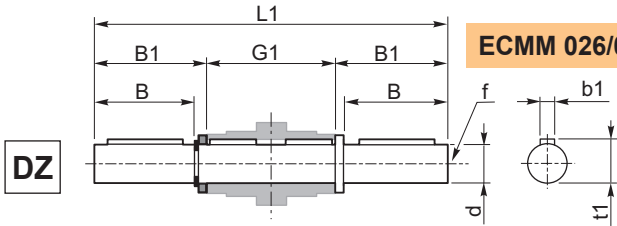

ECMM 026/030 - ECMM 063/130

Single and double output shaft

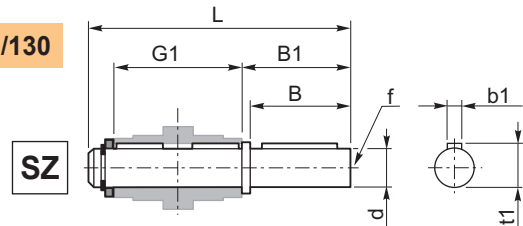

ECMM	d _{h7}	B	B1	G1	L	L1	f	b1	t1
026/030	14	30	32.5	63	102	128	M6	5	16
026/040 030/040	18	40	43	78	128	164	M6	6	20.5
026/050 030/050	25	50	53.5	92	153	199	M10	8	28
030/063	25	50	53.5	112	173	219	M10	8	28
040/070	28	60	63.5	120	192	247	M10	8	31
040/075	28	60	63.5	120	192	247	M10	8	31
040/090	35	80	84.5	140	234	309	M12	10	38
050/110	42	80	84.5	155	249	324	M16	12	45
063/130	45	80	85	170	265	340	M16	14	48.5

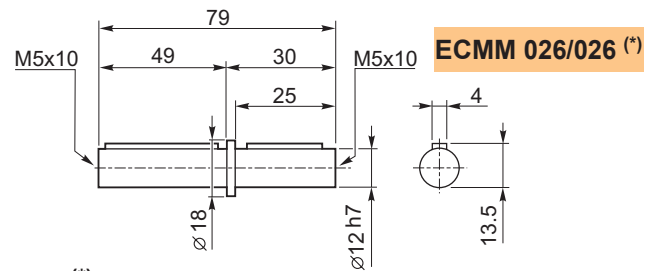

ECMM 026/026 (*)

(*)
Nota: disponibile solo per cavo uscita Ø12
Note: available for output hollow shaft Ø12 only

Braccio di reazione

ECMM	K1	G	KG	KH	R
026/030	85	14	23	8	15
026/040 030/040	100	14	31	10	18
026/050 030/050	100	14	38	10	18
030/063	150	14	47.5	10	18
040/070	200	25	46.5	20	30
040/075	200	25	46.5	20	30
040/090	200	25	56.5	20	30
050/110	250	30	62	25	35
063/130	250	30	69	25	35

Torque arm

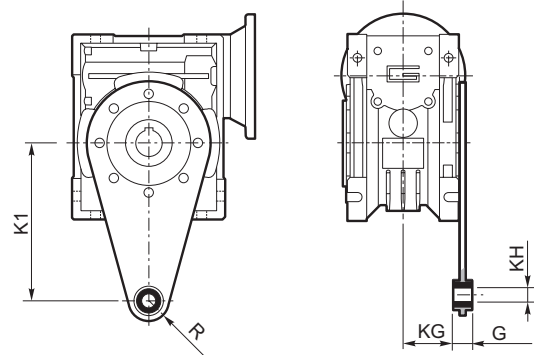

 **TRANSTECNO SRL**
HEADQUARTERS

Company subject to the management
and coordination of INTERPUMP GROUP SPA
Via Caduti di Sabbiano, 11/D-E
40011 Anzola dell'Emilia (BO)
ITALY
T+39 051 64 25 811
F +39 051 73 49 43
sales@transtecno.com
www.transtecno.com

**TRANSTECNO®**
the modular gearmotor
MEMBER OF INTERPUMP GROUP



 **HANGZHOU INTERPUMP
POWER TRANSMISSIONS CO LTD**
No.4 Xiuyan Road Fengdu Industry Zone
Pingyao Town Yuhang District
Hangzhou City, Zhejiang Province
311115 – CHINA
T +86 571 86 92 02 60
info-china@transtecno.cn
www.transtecno.cn

 **TRANSTECNO IBÉRICA
THE MODULAR GEARMOTOR, S.A.**
Carrer de la Ciència, 45
08840 Viladecans (Barcelona) - SPAIN
T +34 931 598 950
info@transtecno.es
www.transtecno.es

 **TRANSTECNO B.V.**
Siliciumweg 32
3812 SX Amersfoort - NETHERLANDS
T +31(0) 33 45 19 505
info@transtecno.nl
www.transtecno.nl

 **TRANSTECNO AANDRIJFTECHNIEK B.V.**
Siliciumweg 32
3812 SX Amersfoort - NETHERLANDS
T +31 (0) 33 20 47 006
info@transtecnoaandrijftechniek.nl
www.transtecnoaandrijftechniek.nl

 **MA TRANSTECNO S.A.P.I. DE C.V.**
Julián Sepúlveda Dávila #107,
Parque Industrial SG
Apodaca, Nuevo León, CP. 66640
MÉXICO
T +52 8113340920
info@transtecno.com.mx
www.transtecno.com.mx

 **TRANSTECNO USA**
8 Creek Parkway,
Boothwyn PA 19061-8136 - UNITED STATES
T +1 (610) 4970154

TRANSTECNO USA – WEST COAST BRANCH
14561 Fryelands Blvd SE
Monroe, WA 98272 - UNITED STATES
T +1 360-863-1300
usaoffice@transtecno.com
www.transtecno.com

 **TRANSTECNO CANADA**
51 B Caldari Road Unit 10
Vaughan, ON L4K 4G3 - CANADA
T +1 905 761 0762
canadaoffice@transtecno.com
www.transtecno.com

 **TRANSTECNO INDIA**
#6A, Sipcot Industrial complex, Phase-1,Elasagiri Road
Hosur – 635126 Tamilnadu - INDIA
T +91 4344 274434
M +91 81443 88800

TRANSTECNO INDIA – NORTH BRANCH
Plot No: 3 A, Sector 2, IIE, Sidcul, Pantnagar
U.S. Nagar, Uttarakhand – 263153 - INDIA
indiaoffice@transtecno.com
www.transtecno.com

 **TRANSTECNO BRAZIL**
Rua Gilberto de Zorzi, 525 Forqueta - CEP. 95115-730
CX Postal 3544 Caxias do Sul RS – BRAZIL

TRANSTECNO BRAZIL – SÃO PAULO BRANCH
R. Mafalda Barnabe Soliane, 314 – CEP. 13347-610
Indaiatuba, São Paulo - BRAZIL
T +55 19 3437 2520

TRANSTECNO BRAZIL – PORTO ALEGRE BRANCH
Rua Dr. Freire Alemão 155 / 402 - CEP. 90450-060
Auxiliadora Porto Alegre RS - BRAZIL
T +55 51 4042 0916
M +55 51 811 45 962
braziloffice@transtecno.com
www.transtecno.com.br

 **INTERPUMP ANTRIEBSTECHNIK GMBH**
Büro Stuttgart - GERMANY
T +49 (0)171 4781909
germanoffice@transtecno.com
www.transtecno.com

 **SALES OFFICE OCEANIA**
Unit 5, 12 Nyholt Drive, Yatala 4207
Queensland - AUSTRALIA
T +61 07 3800 0103
M +61 04 38060997

UNIT 9, 94 Boundary Rd, Sunshine West 3020
Victoria - AUSTRALIA
T +61 9312 4722
oceaniaoffice@transtecno.com
www.transtecno.com.au