

TRANSTECNO[®]
the modular gearmotor

EC IP66

EC IP66



Ferrite

Motori elettrici CC IP66
IP66 DC electric motors



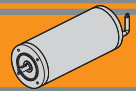

	Indice	Index	Pag. Page
EC070.120.66 EC070.240.66	Caratteristiche	<i>Features</i>	12
	Dimensioni	<i>Dimensions</i>	12
	Prestazioni	<i>Performances</i>	13
EC100.120.66 EC100.240.66	Caratteristiche	<i>Features</i>	14
	Dimensioni	<i>Dimensions</i>	14
	Prestazioni	<i>Performances</i>	15
EC180.120.66 EC180.240.66	Caratteristiche	<i>Features</i>	16
	Dimensioni	<i>Dimensions</i>	16
	Prestazioni	<i>Performances</i>	17
EC250.120.66 EC250.240.66	Caratteristiche	<i>Features</i>	18
	Dimensioni	<i>Dimensions</i>	18
	Prestazioni	<i>Performances</i>	19
EC350.120.66 EC350.240.66	Caratteristiche	<i>Features</i>	110
	Dimensioni	<i>Dimensions</i>	110
	Prestazioni	<i>Performances</i>	111
EC600.120.66 EC600.240.66	Caratteristiche	<i>Features</i>	112
	Dimensioni	<i>Dimensions</i>	112
	Prestazioni	<i>Performances</i>	113

Questa sezione annulla e sostituisce ogni precedente edizione o revisione. Qualora questa sezione non Vi sia giunta in distribuzione controllata, l'aggiornamento dei dati ivi contenuto non è assicurato. **In tal caso la versione più aggiornata è disponibile sul nostro sito internet www.transtecno.com**

*This section replaces any previous edition and revision. If you obtained this catalogue other than through controlled distribution channels, the most up to date content is not guaranteed. **In this case the latest version is available on our web site www.transtecno.com***



EC070.120.66 - EC070.240.66

Caratteristiche

Features

Costruzione	Tubolare, senza ventilazione
Grandezza	Ø 65 mm
Potenza	100 W S2 (70 W S1)
Magneti	2
Supporti	Cuscinetti a sfera
Fori di montaggio	4
Alimentazione	Bassa tensione, 12 o 24 Vcc
Spazzole	N° 2 interne di composto grafite-rame
Cavo di alimentazione	Lunghezza: 1000 mm

Construction	Tubular, without fan
Size	Ø 65 mm
Power	100 W S2 (70 W S1)
Magnets	2
Bearings	Ball bearings
Mounting holes	4
Power supply	Low voltage, 12 or 24 Vdc
Brushes	2 inside brushes made of graphite/copper composite
Electric cable	Length: 1000 mm

Tipo Type	S	Pn [W]	V [V]	I [A]	IC	FF	Mn [Nm]	n ₁ [min ⁻¹]	IP	Kg
EC070.120.66	S1	70	12	8.4	F	1	0.22	3000	66	1.7
	S2 30'	100		11.8			0.31			
EC070.240.66	S1	70	24	4.2			0.22			
	S2 30'	100		5.9			0.31			

Dimensioni

Dimensions

EC070.120.66 EC070.240.66

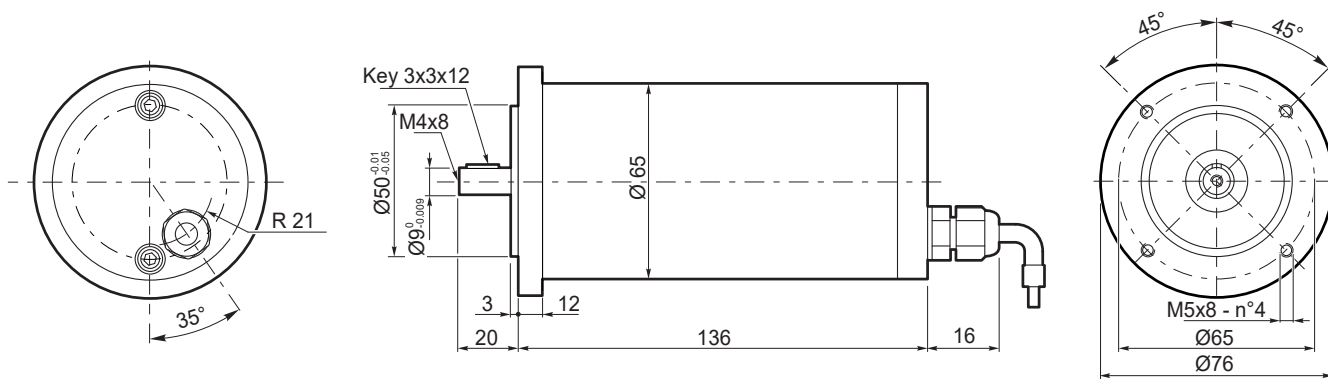



EC070.120.66 - EC070.240.66

Prestazioni

Performances

EC070.120.66

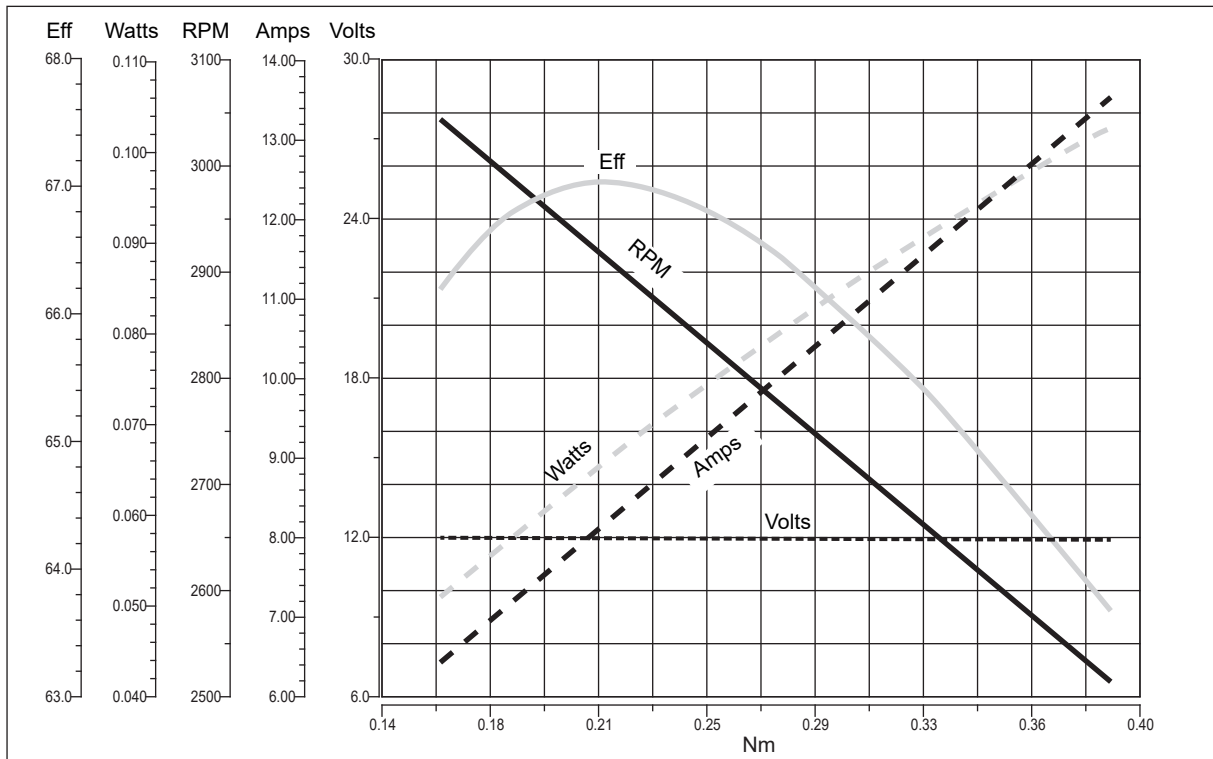

EC IP66

EC070.240.66

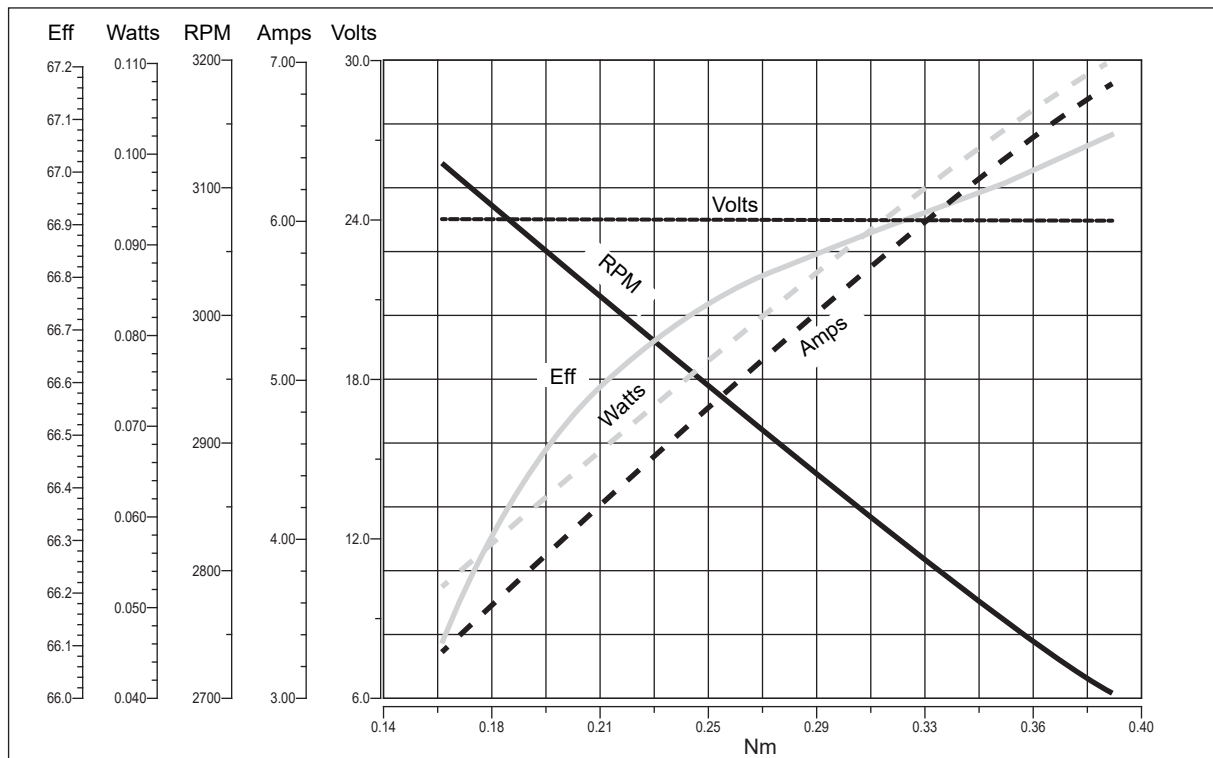

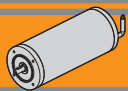

EC100.120.66 - EC100.240.66

Caratteristiche

Features

Costruzione	Tubolare, senza ventilazione
Grandezza	Ø 80 mm
Potenza	140 W S2 (100 W S1)
Magneti	2
Supporti	Cuscinetti a sfera
Fori di montaggio	4
Alimentazione	Bassa tensione, 12 o 24 Vcc
Cavo di alimentazione	Lunghezza: 1000 mm

Construction	Tubular, without fan
Size	Ø 80 mm
Power	140 W S2 (100 W S1)
Magnets	2
Bearings	Ball bearings
Mounting holes	4
Power supply	Low voltage, 12 or 24 Vdc
Electric cable	Length: 1000 mm

Tipo Type	S	Pn [W]	V [V]	I [A]	IC	FF	Mn [Nm]	n ₁ [min ⁻¹]	IP	Kg
EC100.120.66	S1	100	12	12	F	1	0.31	3000	66	2.7
	S2 25'	140		16.8			0.43			
EC100.240.66	S1	100	24	6			0.31			
	S2 25'	140		8.4			0.43			

Dimensioni

Dimensions

EC100.120.66 EC100.240.66

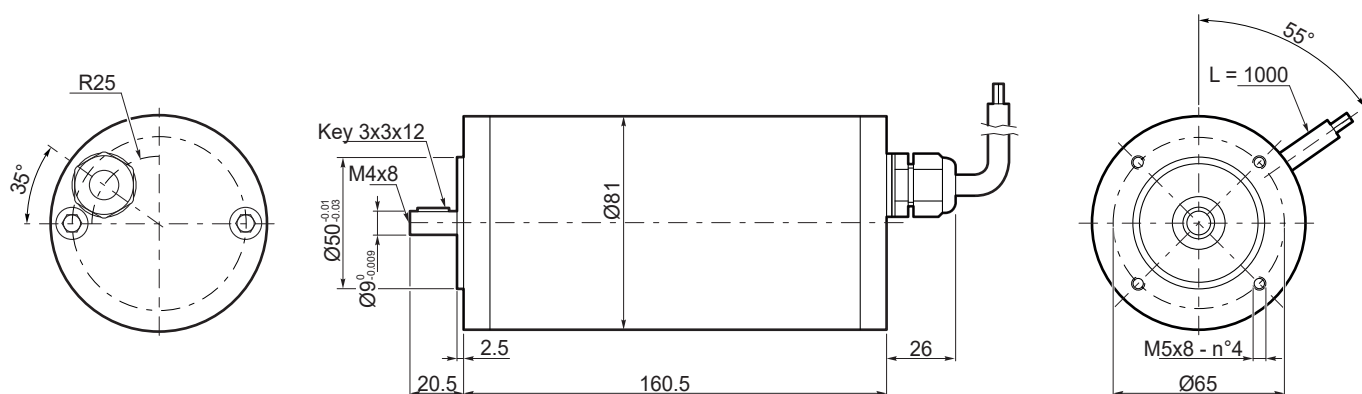

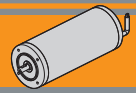

EC100.120.66

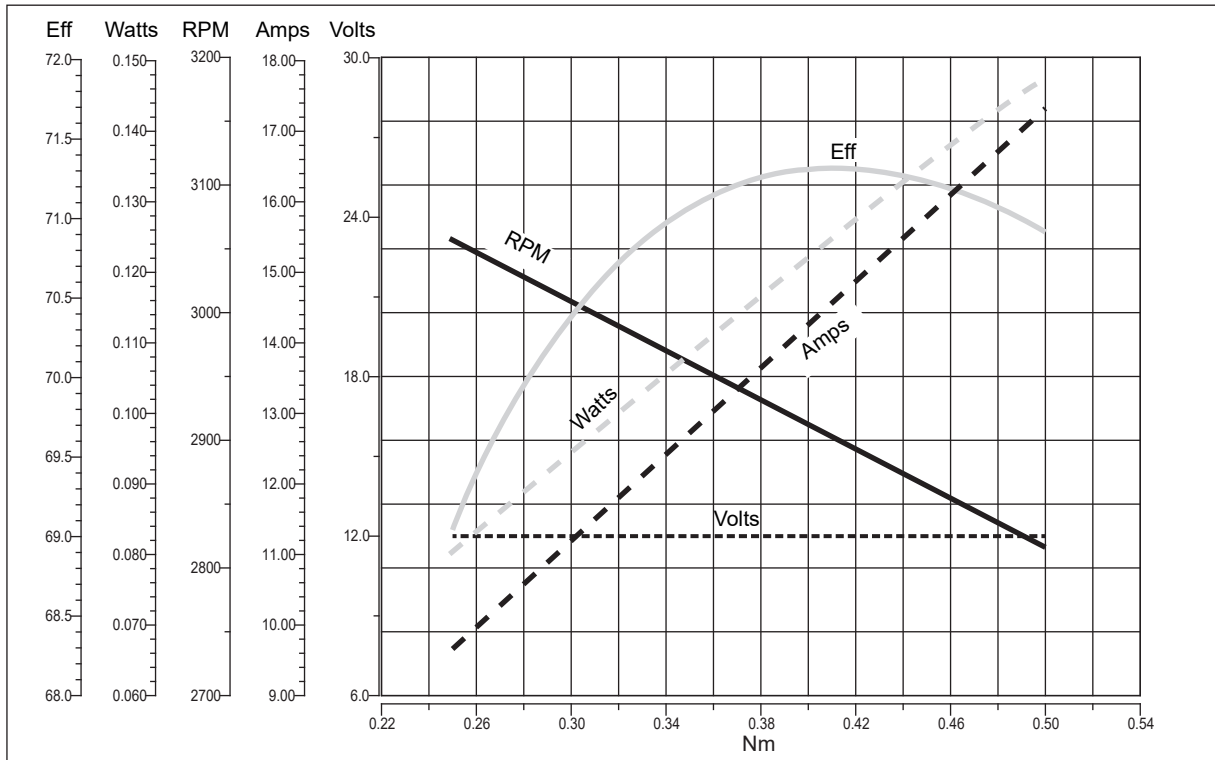

EC IP66

EC100.240.66

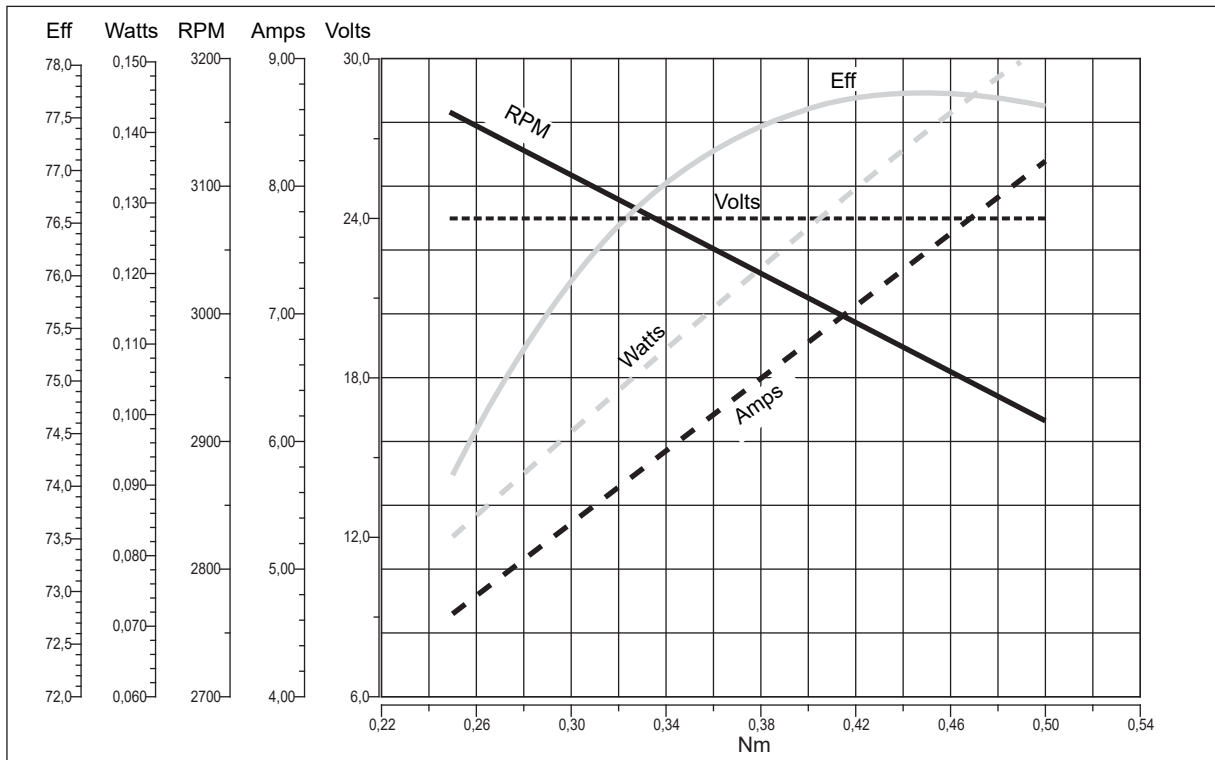

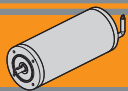

EC180.120.66 - EC180.240.66

Caratteristiche

Features

Costruzione	Tubolare, senza ventilazione
Grandezza	Ø 80 mm
Potenza	250 W S2 (180 W S1)
Magneti	2
Supporti	Cuscinetti a sfera
Fori di montaggio	4
Alimentazione	Bassa tensione, 12 o 24 Vcc
Cavo di alimentazione	Lunghezza: 1000 mm

Construction	Tubular, without fan
Size	Ø 80 mm
Power	250 W S2 (180 W S1)
Magnets	2
Bearings	Ball bearings
Mounting holes	4
Power supply	Low voltage, 12 or 24 Vdc
Electric cable	Length: 1000 mm

Tipo Type	S	Pn [W]	V [V]	I [A]	IC	FF	Mn [Nm]	n ₁ [min ⁻¹]	IP	Kg
EC180.120.66	S1	180	12	21.5	F	1	0.57	3000	66	3.4
	S2 25'	250		30			0.8			
EC180.240.66	S1	180	24	10.8						
	S2 25'	250		15			0.8			

Dimensioni

Dimensions

EC180.120.66
EC180.240.66

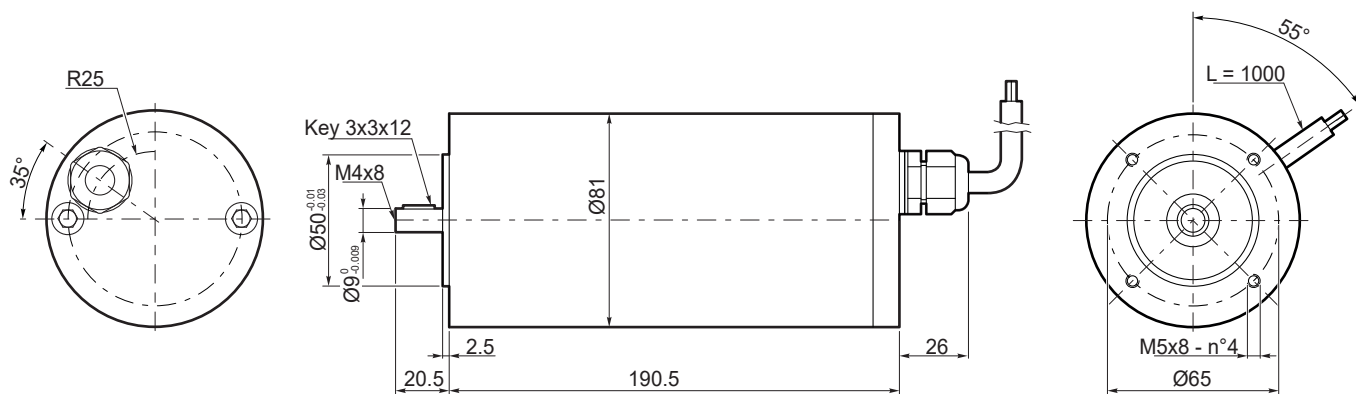

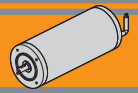

EC180.120.66

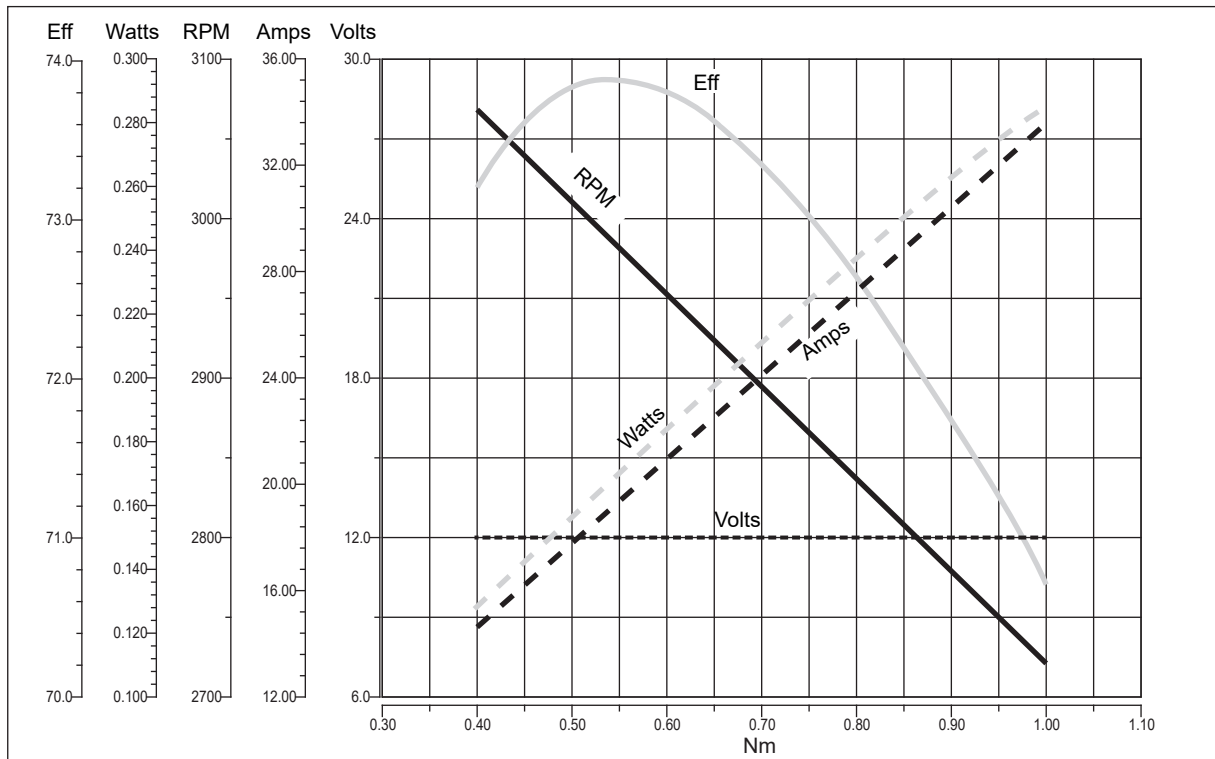

EC IP66

EC180.240.66

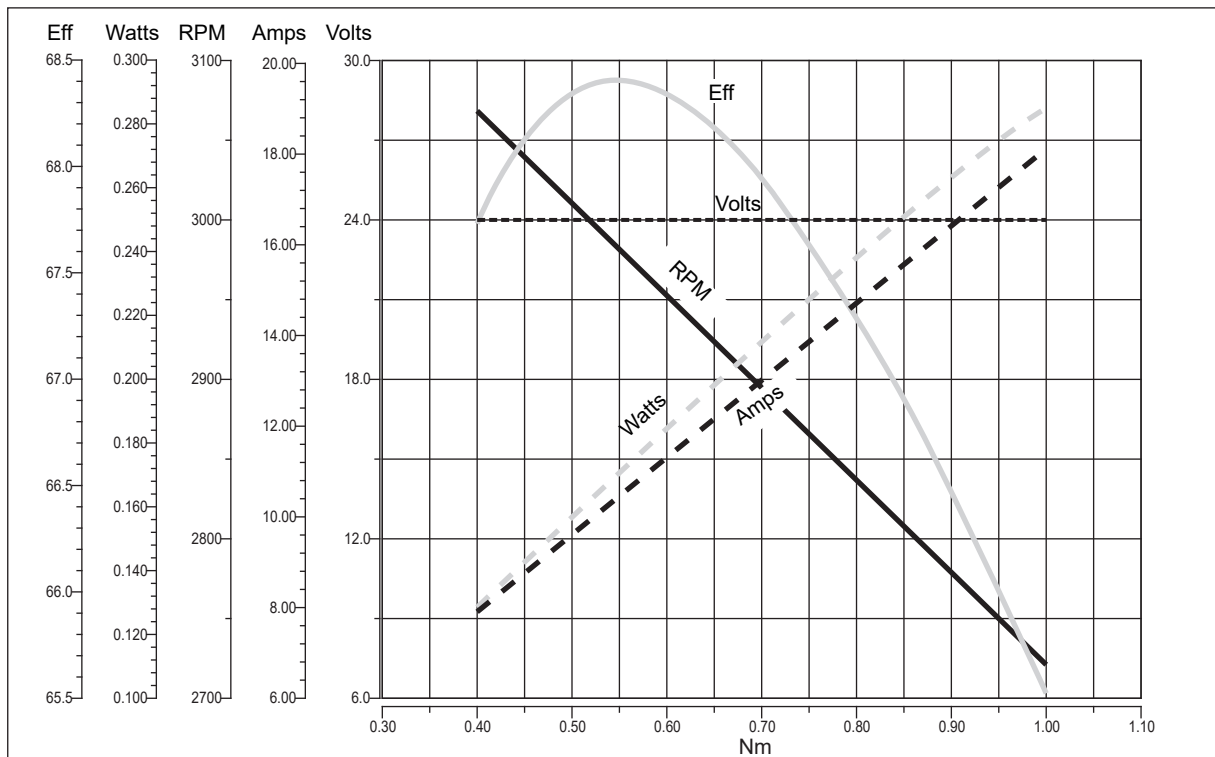

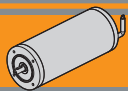

EC250.120.66 - EC250.240.66

Caratteristiche

Features

Costruzione	Tubolare, senza ventilazione
Grandezza	Ø 104 mm
Potenza	350 W S2 (250 W S1)
Magneti	4
Supporti	Cuscinetti a sfera
Fori di montaggio	8
Alimentazione	Bassa tensione, 12 o 24 Vcc
Terminali	2 con doppio dado di fissaggio

Construction	Tubular, without fan
Size	Ø 104 mm
Power	350 W S2 (250 W S1)
Magnets	4
Bearings	Ball bearings
Mounting holes	8
Power supply	Low voltage, 12 or 24 Vdc
Leads terminals	2, with double nut

Tipo Type	S	Pn [W]	V [V]	I [A]	IC	FF	Mn [Nm]	n ₁ [min ⁻¹]	IP	Kg
EC250.120.66	S1	250	12	30	F	1	0.8	3000	66	4.15
	S2 25'	350		38.5			1.12			
EC250.240.66	S1	250	24	15			0.8			
	S2 25'	350		20.5			1.12			

Dimensioni

Dimensions

EC250.120.66

EC250.240.66

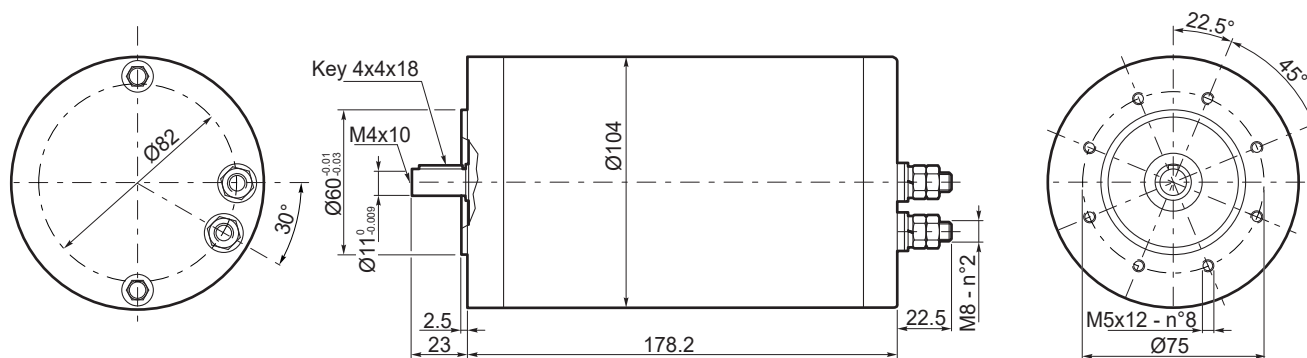



EC250.120.66

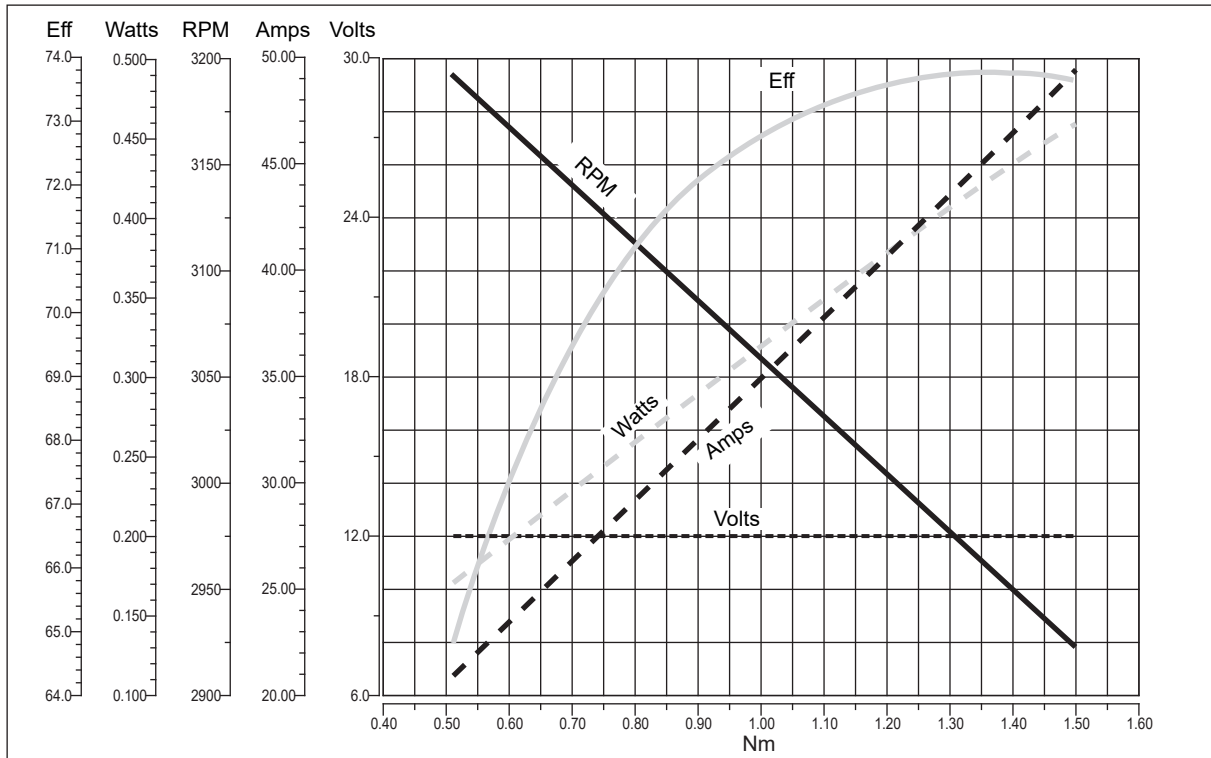

EC IP66

EC250.240.66

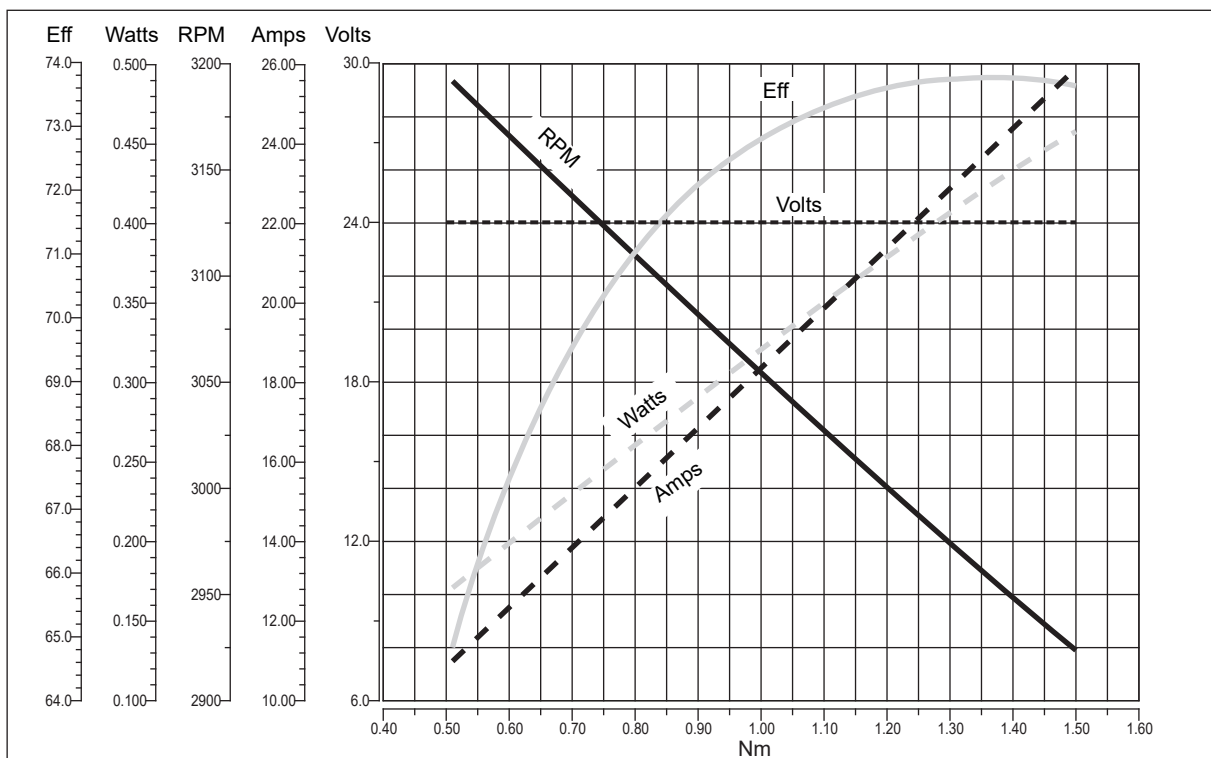



EC350.120.66 - EC350.240.66

Caratteristiche

Features

Costruzione	Tubolare, senza ventilazione
Grandezza	Ø 110 mm
Potenza	500 W S2 (350 W S1)
Magneti	4
Supporti	Cuscinetti a sfera
Fori di montaggio	8
Alimentazione	Bassa tensione, 12 o 24 Vcc
Terminali	2 con dadi di fissaggio

Construction	Tubular, without fan
Size	Ø 110 mm
Power	500 W S2 (350 W S1)
Magnets	4
Bearings	Ball bearings
Mounting holes	8
Power supply	Low voltage, 12 or 24 Vdc
Leads terminals	2, with double nut

Tipo Type	S	Pn [W]	V [V]	I [A]	IC	FF	Mn [Nm]	n ₁ [min ⁻¹]	IP	Kg
EC350.120.66	S1	350	12	42	F	1	1.12	3000	66	5.1
	S2 30'	500		58.8			1.57			
EC350.240.66	S1	350	24	21			1.12			5.3
	S2 30'	500		29.4			1.57			

Dimensioni

Dimensions

EC350.120.66
EC350.240.66

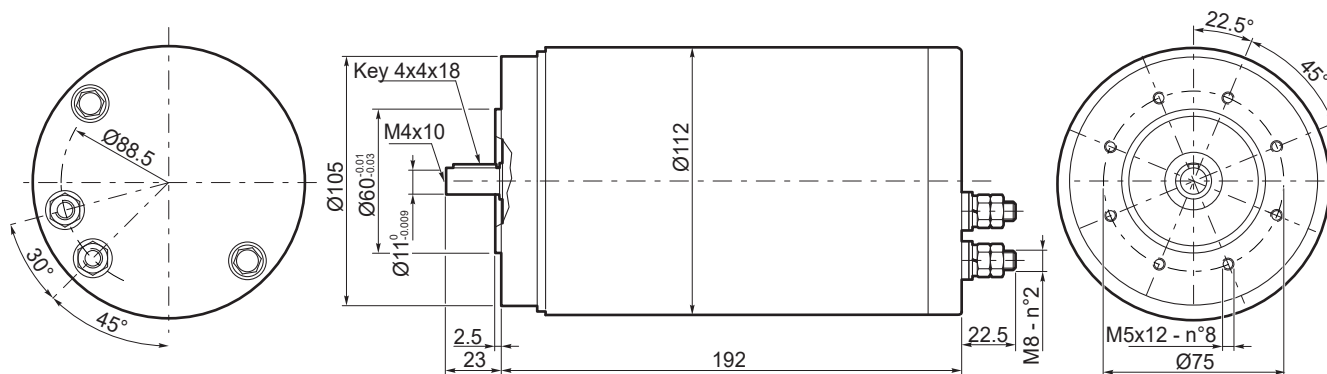



EC350.120.66

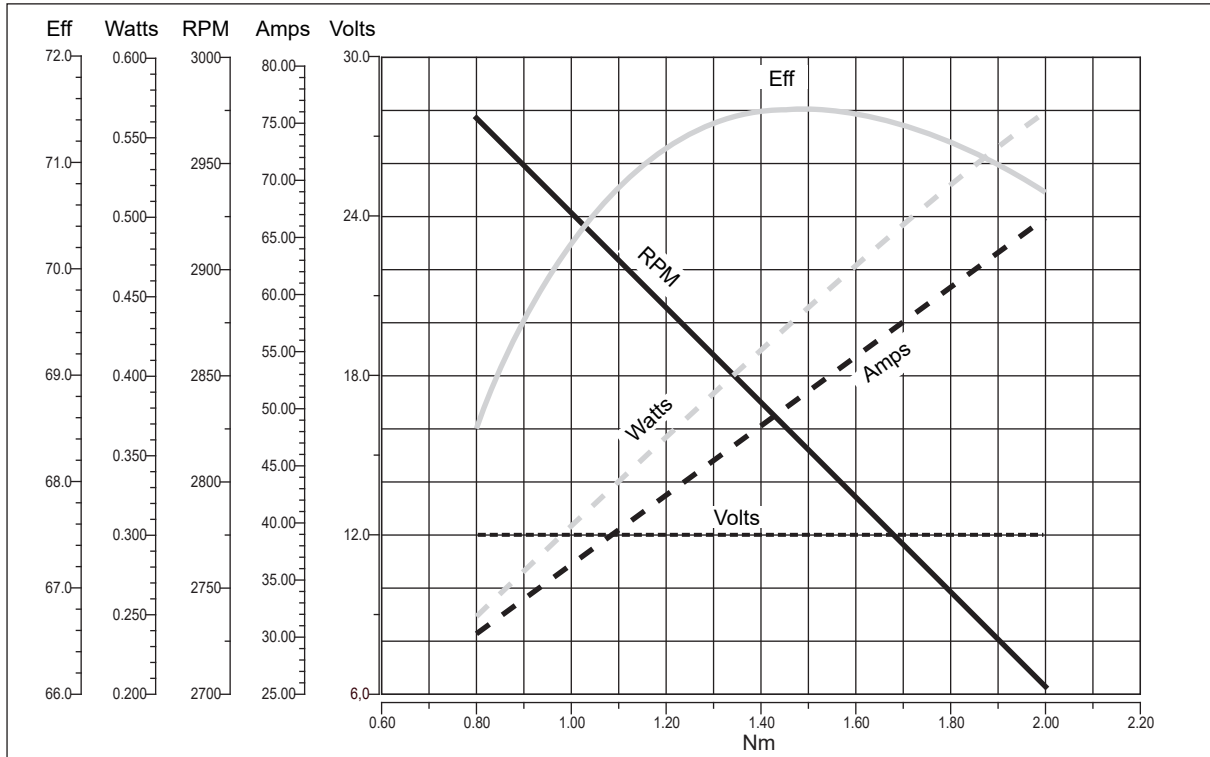

EC IP66

EC350.240.66

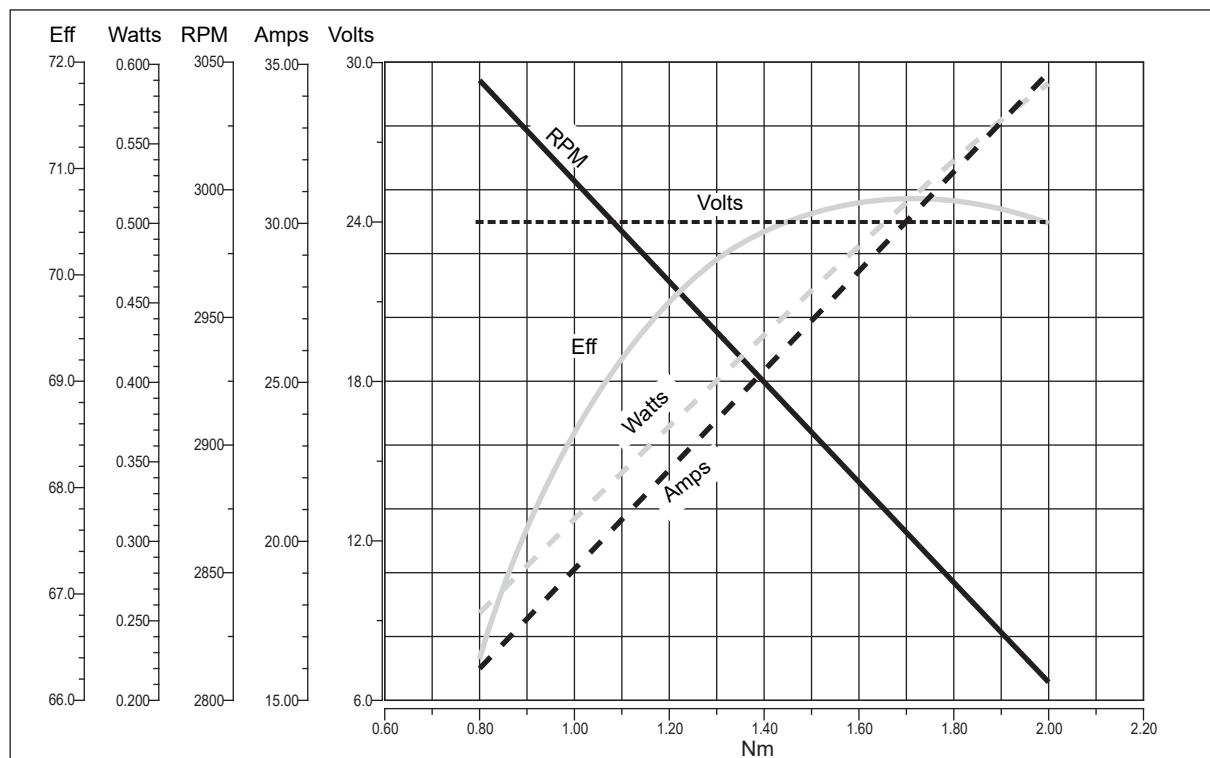

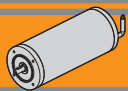

EC600.120.66 - EC600.240.66

Caratteristiche

Features

Costruzione	Tubolare, senza ventilazione
Grandezza	Ø 110 mm
Potenza	800 W S2 (600 W S1)
Magneti	4
Supporti	Cuscinetti a sfera
Fori di montaggio	8
Alimentazione	Bassa tensione, 12 o 24 Vcc
Terminali	2 con doppio dado di fissaggio

Construction	Tubular, without fan
Size	Ø 110 mm
Power	800 W S2 (600 W S1)
Magnets	4
Bearings	Ball bearings
Mounting holes	8
Power supply	Low voltage, 12 or 24 Vdc
Leads terminals	2, with double nut

Tipo Type	S	Pn [W]	V [V]	I [A]	IC	FF	Mn [Nm]	n ₁ [min ⁻¹]	IP	Kg
EC600.120.66	S1	600	12	71	F	1	1.91	3000	66	6.6
	S2 30'	800		94.4			2.54			
EC600.240.66	S1	600	24	35.5			1.91			7.1
	S2 30'	800		47.2			2.54			

Dimensioni

Dimensions

EC600.120.66

EC600.240.66

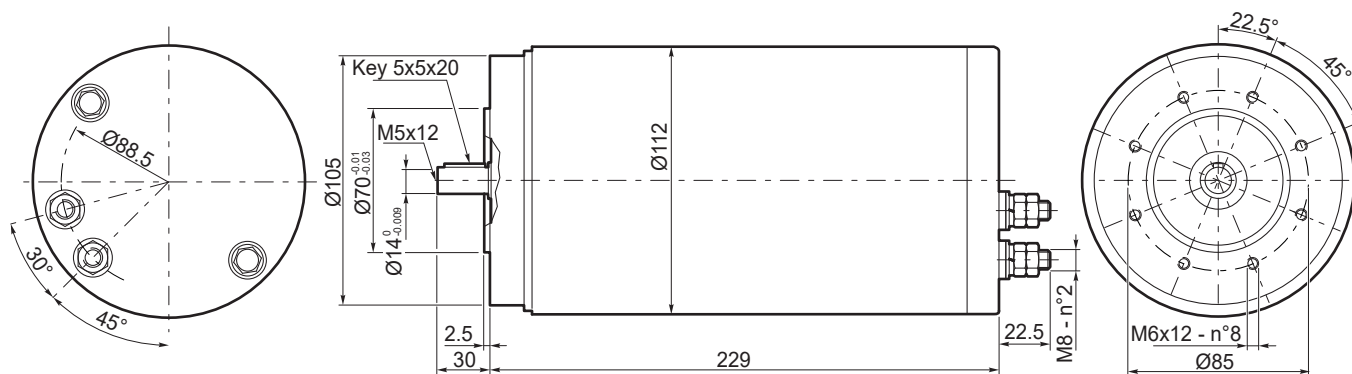



EC600.120.66

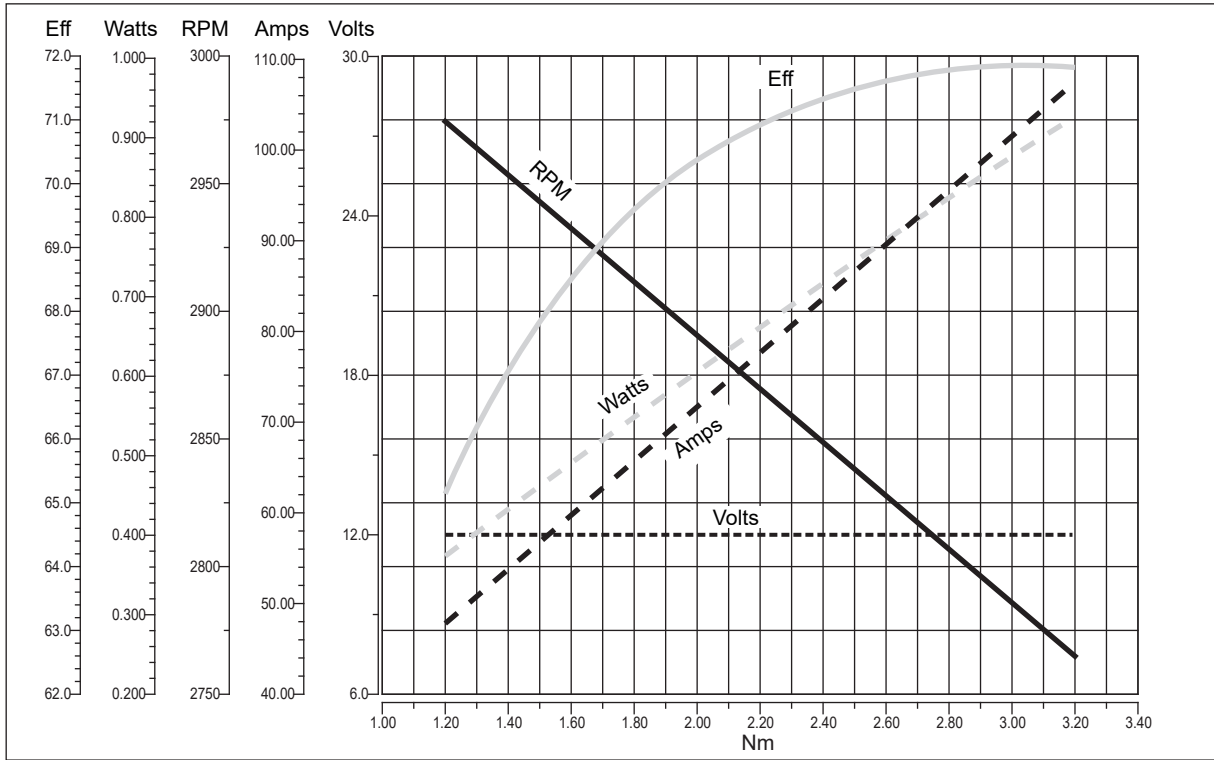

EC IP66

EC600.240.66

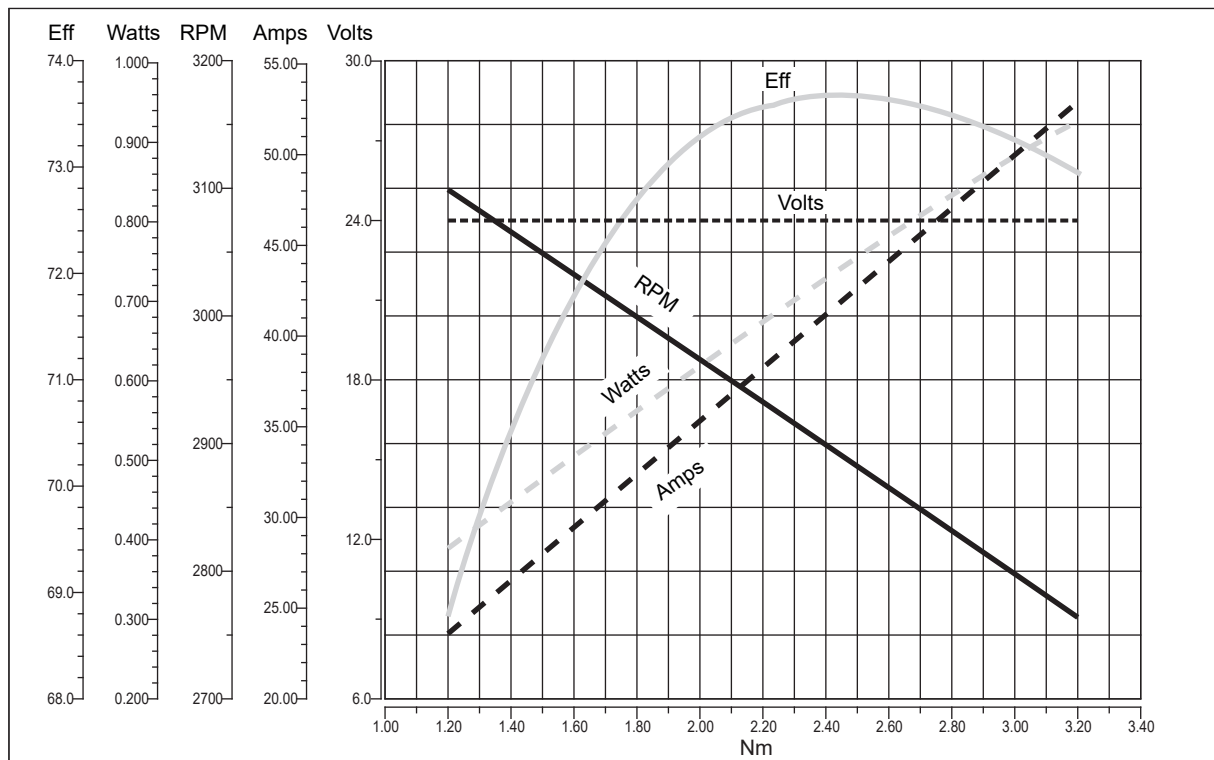



Note/Notes

 **TRANSTECNO SRL
HEADQUARTERS**

Company subject to the management
and coordination of INTERPUMP GROUP SPA
Via Caduti di Sabbiano, 11/D-E
40011 Anzola dell'Emilia (BO)
ITALY
T+39 051 64 25 811
F +39 051 73 49 43
sales@transtecno.com
www.transtecno.com

TRANSTECNO®
the modular gearmotor

MEMBER OF INTERPUMP GROUP



 **HANGZHOU INTERPUMP
POWER TRANSMISSIONS CO LTD**
No.4 Xiuyan Road Fengdu Industry Zone
Pingyao Town Yuhang District
Hangzhou City, Zhejiang Province
311115 – CHINA
T +86 571 86 92 02 60
info-china@transtecno.cn
www.transtecno.cn

 **TRANSTECNO IBÉRICA
THE MODULAR GEARMOTOR, S.A.**
Carrer de la Ciència, 45
08840 Viladecans (Barcelona) - SPAIN
T +34 931 598 950
info@transtecno.es
www.transtecno.es

 **TRANSTECNO B.V.**
Siliciumweg 32
3812 SX Amersfoort – NETHERLANDS
T +31(0) 33 45 19 505
info@transtecno.nl
www.transtecno.nl

 **TRANSTECNO AANDRIJFTECHNIEK B.V.**
Siliciumweg 32
3812 SX Amersfoort – NETHERLANDS
T +31 (0) 33 20 4 7 006
info@transtecnoaandrijftechnik.nl
www.transtecnoaandrijftechnik.nl

 **MA TRANSTECNO S.A.P.I. DE C.V.**
Av. Mundial # 176, Parque Industrial
JM Apodaca, Nuevo León,
C.P. 66633 - MÉXICO
T +52 8113340920
info@transtecno.com.mx
www.transtecno.com.mx

 **TRANSTECNO USA**
8 Creek Parkway,
Boothwyn PA 19061-8136 - UNITED STATES
T + 1 (610) 4970154

TRANSTECNO USA – WEST COAST BRANCH
14561 Fryelands Blvd SE
Monroe, WA 98272 - UNITED STATES
T +1 360-863-1300
usaoffice@transtecno.com
www.transtecno.com

 **TRANSTECNO CANADA**
51 B Caldari Road Unit 10
Vaughan, ON L4K 4G3 - CANADA
T +1 905 761 0762
canadaoffice@transtecno.com
www.transtecno.com

 **TRANSTECNO INDIA**
#6A, Sipcot Industrial complex, Phase-1,Elasagiri Road
Hosur – 635126 Tamilnadu - INDIA
T +91 4344 274434
M +91 81443 88800

TRANSTECNO INDIA – NORTH BRANCH
Plot No: 3 A, Sector 2, IIE, Sidcul, Pantnagar
U.S. Nagar, Uttarakhand – 263153 - INDIA
indiaoffice@transtecno.com
www.transtecno.com

 **TRANSTECNO BRAZIL**
Rua Gilberto de Zorzi, 525 Forqueta - CEP. 95115-730
CX Postal 3544 Caxias do Sul RS – BRAZIL

TRANSTECNO BRAZIL – SÃO PAULO BRANCH
R. Mafalda Barnabe Soliane, 314 – CEP. 13347-610
Indaiatuba, São Paulo - BRAZIL
T +55 19 3437 2520

TRANSTECNO BRAZIL – PORTO ALEGRE BRANCH
Rua Dr. Freire Alemão 155 / 402 - CEP. 90450-060
Auxiliadora Porto Alegre RS - BRAZIL
T +55 51 3251 5447
M +55 51 811 45 962
braziloffice@transtecno.com
www.transtecno.com.br

 **INTERPUMP ANTRIEBSTECHNIK GMBH**
Büro Stuttgart - GERMANY
T +49 (0)171 4781909
germanoffice@transtecno.com
www.transtecno.com

 **SALES OFFICE OCEANIA**
Unit 5, 12 Nyholt Drive, Yatala 4207
Queensland - AUSTRALIA
T +61 07 3800 0103
M +61 04 38060997

 **UNIT 9, 94 Boundary Rd, Sunshine West 3020
Victoria - AUSTRALIA
T +61 9312 4722
oceaniaoffice@transtecno.com
www.transtecno.com.au**