

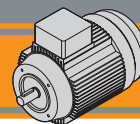

**Motori elettrici asincroni CA**  
**AC asynchronous electric motors**







<b>Indice</b>	<b>Index</b>	Pag. Page
Caratteristiche tecniche	<i>Technical characteristics</i>	<b>R2</b>
Designazione	<i>Classification</i>	<b>R2</b>
Versioni	<i>Versions</i>	<b>R2</b>
Simbologia e formule	<i>Symbols and formulas</i>	<b>R3</b>
Dati tecnici	<i>Technical data</i>	<b>R3</b>
Dati tecnici: dimensioni motori	<i>Technical data: motor dimensions</i>	<b>R4</b>
Tipi di servizio IEC	<i>IEC duty services</i>	<b>R5</b>
Classe di isolamento termico	<i>Thermal insulation class</i>	<b>R5</b>
Serie TS - Funzionamento a 60 Hz	<i>TS Series - 60 Hz line power supply</i>	<b>R7</b>
Dati pressacavi	<i>Cable glands data</i>	<b>R7</b>
Connessioni e collegamenti	<i>Connection diagram</i>	<b>R7</b>
Targhetta	<i>Nameplate</i>	<b>R7</b>

Questa sezione annulla e sostituisce ogni precedente edizione o revisione. Qualora questa sezione non Vi sia giunta in distribuzione controllata, l'aggiornamento dei dati ivi contenuto non è assicurato. **In tal caso la versione più aggiornata è disponibile sul nostro sito internet [www.transtecno.com](http://www.transtecno.com)**

*This section replaces any previous edition and revision. If you obtained this catalogue other than through controlled distribution channels, the most up to date content is not guaranteed. **In this case the latest version is available on our web site [www.transtecno.com](http://www.transtecno.com)***

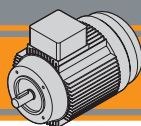

**Caratteristiche tecniche**

**Technical characteristics**

I motori della serie TS sono tutti dotati di ventola di raffreddamento. Costruiti in alluminio e disponibili nelle versioni B5, B14.

All TS series motors are fan cooled and made with an aluminium frame in version B5, B14.

La serie TS comprende motori ad induzione trifase 230/400 Vca a 50 Hz e 275/480 Vca a 60 Hz 4 poli, per potenze da 0.09 kW fino a 2.2 kW.

TS range includes induction three phase 4 poles motors 230/400 Vac at 50 Hz and 275/480 Vac at 60 Hz, it covers power sizes from 0.09 kW up to 2.2 kW.

Altre caratteristiche standard dei motori TS sono:

Standard features are:

- Isolamento termico di classe F
- Grado di protezione IP55
- Temperatura ambiente: -20 °C ÷ +40 °C.

- Class F thermal insulation
- IP55 enclosure protection
- Ambient temperature: -20 °C ÷ +40 °C.

**Designazione**

**Classification**

MOTORE TRIFASE / THREE PHASE MOTOR								
TS	63	2	4	0.18	B5	3 ph	230-400 V	50 Hz
Tipo Type	Grandezza Size	Indicativo potenza Power coefficient	Poli Poles	Potenza Power	Forma costruttiva Version	Fasi Phases	Tensione Voltage	Frequenza Frequency
TS trifase threephase	vedi tabelle see tables	1-2-3-S L1-L2	4	0.09 kW ... 2.2 kW	B5 B14	3 ph	230-400 V 275-480 V	50Hz 60Hz

**Versioni**

**Versions**

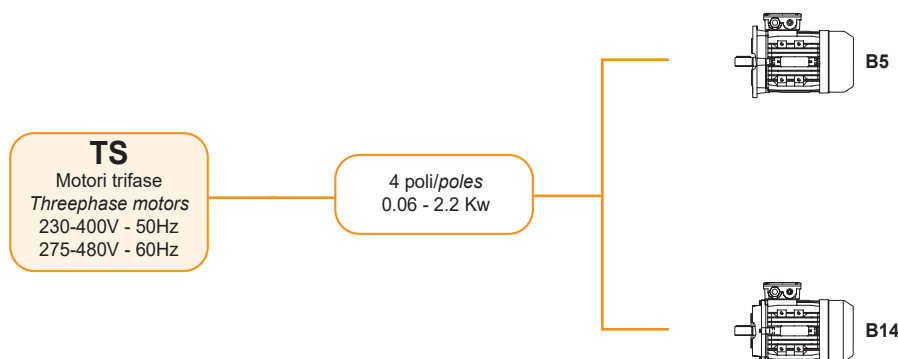

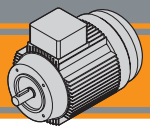

**Simbologia e formule**

**Symbols and formulas**

$P_n$	[kW]	Potenza nominale	Rated power
$I_n$	[A]	Corrente nominale (a 400V)	Rated current (at 400V)
$M_n$	[Nm]	Coppia nominale	Rated torque
$n_n$	[rpm]	Velocità nominale	Rated speed
LR	[dB]	Livello di rumorosità	Noise Level
$M_s / M_n$		Rapporto coppia spunto / coppia nominale	Ratio start torque / rated torque
$M_k / M_n$		Rapporto coppia massima / coppia nominale	Ratio max torque / rated torque
$M_{sel} / M_n$		Rapporto coppia di sella (minima) / coppia nominale	Ratio saddle torque / rated torque
$I_s / I_n$		Rapporto corrente di spunto / corrente nominale	Ratio start current / rated current
$\cos\varphi$		Fattore di potenza al carico nominale	Power factor at rated torque load
$\eta$		Rendimento al carico nominale	Efficiency at rated torque load
Potenza Power	[HP]	Potenza [kW] x 1.34 circa	Power [kW] x 1.34 (about)
Potenza resa $P_n$ $P_n$ output power	[kW]	Potenza assorbita x $\eta$	Absorbed power x $\eta$
Pot. assorbita Absorbed power	[kW]	$\frac{\sqrt{3} \times I \times PF}{1000}$ (monofase)	$\frac{\sqrt{3} \times I \times PF}{1000}$ (singlephase)
		$\frac{\sqrt{3} \times I \times \sqrt{3} \times PF}{1000}$ (trifase)	$\frac{\sqrt{3} \times I \times \sqrt{3} \times PF}{1000}$ (threephase)
$I_n$ (230 V)		$I_n$ (400 V) x $\sqrt{3}$	$I_n$ (400 V) x $\sqrt{3}$

**Dati tecnici**

**Technical data**

**TS Motori trifase / TS Three phase motors**

(230-400 V / 50 Hz - 1400 min<sup>-1</sup>) poli / poles 4

TS	$P_n$ [kW]	$M_n$ [Nm]	$n_n$ [min <sup>-1</sup> ]	$I_n$ (400V) [A]	$\eta$ %	$\cos\varphi$	$M_s/M_n$	$I_s/I_n$	$M_k/M_n$	$M_{sel}/M_n$	LR [dB]	Massa Mass [Kg]	Servizio Duty
562-4	0.09	0.63	1360	0.45	52	0.59	2.3	4	2.4	2	50	3.2	S1
631-4	0.12	0.84	1360	0.55	52	0.64	2.2	4	2.4	2	52	3.7	
632-4	0.18	1.31	1310	0.70	57	0.65	2.2	4	2.4	2	52	4.2	S3 70%
633-4	0.25	1.78	1340	0.91	60	0.66	2.2	4	2.2	2	54	5.0	
711-4	0.25	1.77	1350	0.84	60	0.72	2.2	6	2.4	1.7	55	5.0	
712-4	0.37	2.58	1370	1.11	65	0.74	2.2	6	2.4	1.7	55	5.8	
713-4	0.55	3.80	1380	1.60	66	0.75	2.2	6	2.4	1.7	57	6.5	
714-4	0.75	5.15	1390	2.20	71.3	0.69	2.7	4.2	2.7	2.4	57	7.7	
801-4	0.55	3.83	1370	1.58	67	0.75	2.2	6	2.4	1.7	58	8.1	
802-4	0.75	5.19	1380	1.93	72	0.78	2.2	6	2.4	1.6	58	9.1	
803-4	1.1	7.55	1390	2.67	76.2	0.78	2.2	6	2.4	1.6	60	11.0	
90S-4	1.1	7.50	1400	2.64	76.2	0.79	2.2	6	2.4	1.6	61	11.7	
90L1-4	1.5	10.2	1400	3.45	78.5	0.8	2.2	6	2.4	1.6	61	14.4	
90L2-4	2.2	15.0	1400	4.90	81	0.8	2.2	7	2.4	1.5	63	17.6	
100L1-4	2.2	14.8	1420	4.84	81	0.81	2.2	7	2.3	1.5	64	19.2	

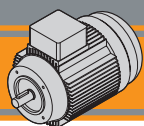

Dimensioni motori trifase serie **TS**

**B5**

**TS Series three phase motor dimensions**

TS	Albero / Shaft					B5											
	D	E	DH	GA	F	P	M	N	S	T	AC	AD	AF	KK	L	LL	V
56	9	20	M3	10.2	3	120	100	80	7	3	117	100	88	1-M16x1.5	196	88	14
63	11	23	M4	12.5	4	140	115	95	10	3	130	108	94	1-M16x1.5	220	94	14
71 1/2 (3/4)	14	30	M5	16	5	160	130	110	10	3.5	147	115	94	1-M20x1.5	241 (255)	94	20
80	19	40	M6	21.5	6	200	165	130	12	3.5	163	133	105	1-M20x1.5	290	105	27
90S	24	50	M8	27	8	200	165	130	12	3.5	183	139	105	1-M20x1.5	312	105	30
90L1	24	50	M8	27	8	200	165	130	12	3.5	183	139	105	1-M20x1.5	337	105	30
100L 1/2	28	60	M10	31	8	250	215	180	15	4	205	152	105	2-M20x1.5	369	105	26

Dimensioni motori trifase serie **TS**

**B14**

**TS Series three phase motor dimensions**

TS	Albero / Shaft					B14											
	D	E	DH	GA	F	P	M	N	S	T	AC	AD	AF	KK	L	LL	V
56	9	20	M3	10.2	3	80	65	50	M5	2.5	117	100	88	1-M16x1.5	196	88	14
63	11	23	M4	12.5	4	90	75	60	M5	2.5	130	108	94	1-M16x1.5	220	94	14
71 1/2 (3/4)	14	30	M5	16	5	105	85	70	M6	2.5	147	115	94	1-M20x1.5	241 (255)	94	20
80	19	40	M6	21.5	6	120	100	80	M6	3	163	133	105	1-M20x1.5	290	105	27
90S	24	50	M8	27	8	140	115	95	M8	3	183	139	105	1-M20x1.5	312	105	30
90L 1/2	24	50	M8	27	8	140	115	95	M8	3	183	139	105	1-M20x1.5	337 / 367	105	30
100L 1	28	60	M10	31	8	160	130	110	M8	3.5	205	152	105	2-M20x1.5	369	105	26

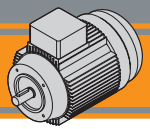

Dati tecnici: dimensioni motori

Technical data: motor dimensions

Dimensioni motori trifase serie **TS**

**B5**

**TS** Series three phase motor dimensions

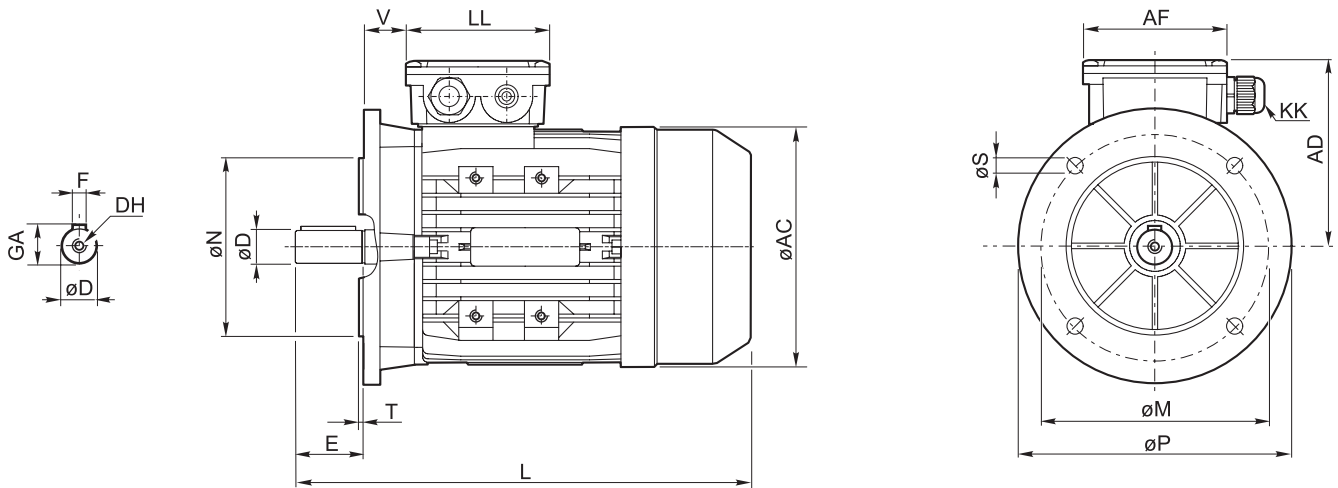

Dimensioni motori trifase serie **TS**

**B14**

**TS** Series three phase motor dimensions

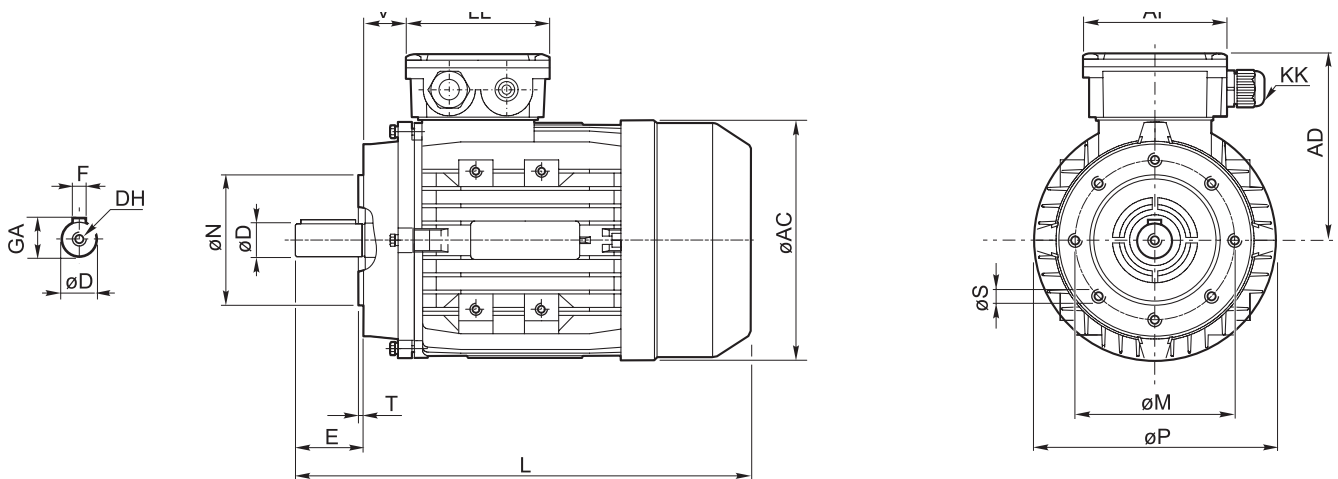

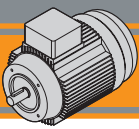

**Tipi di servizio IEC**

**IEC duty cycles**

Il servizio di un motore indica il tipo di utilizzo e la gravosità del ciclo di lavoro.

*The duty cycle of a motor indicates its use and running cycle.*

**Grafico servizi più comuni**

*Most common duty cycles diagram*

N = funzionamento / run  
R = riposo / rest

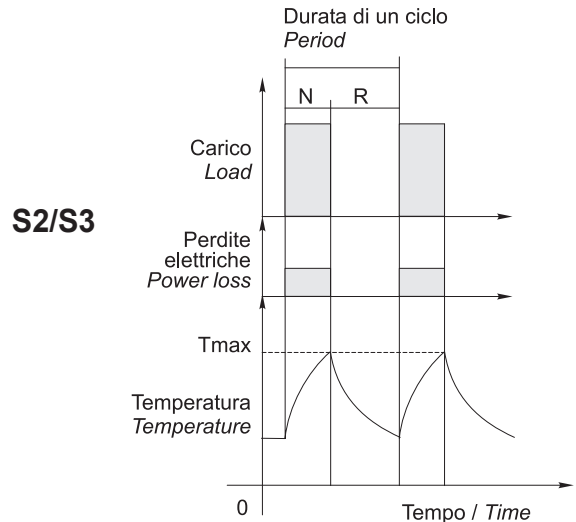
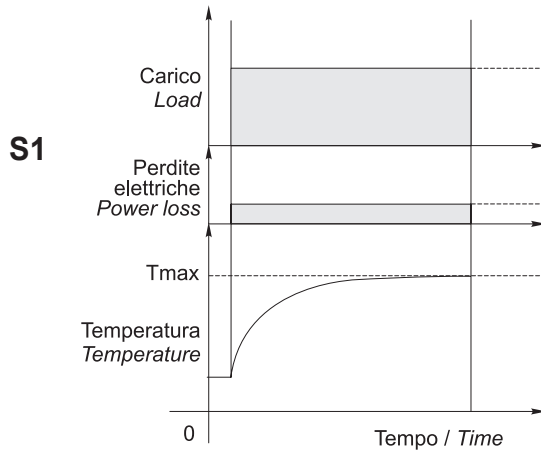

NOTA: Lo stesso motore può essere usato per cicli e servizi diversi, con l'unica limitazione che la temperatura interna non superi mai la Tmax stabilita dalla classe di isolamento termico del motore.

*NOTE: The same motor can run under all duty services, limitation is due to internal temperature that must not override Tmax stated by motor thermal class.*

**Classe di isolamento termico**

**Insulation class**

La classe termica indica il grado di resistenza alla temperatura interna, nel punto più caldo (avvolgimenti). Isolamento termico di classe F.

*Thermal insulation class indicates the level of thermal protection measured at the hottest point inside the motor (windings). Thermal insulation class F.*

Classe Class	Massima temperatura interna Max. windings temp.
E	120°C
B	130°C
F	155°C
H	180°C

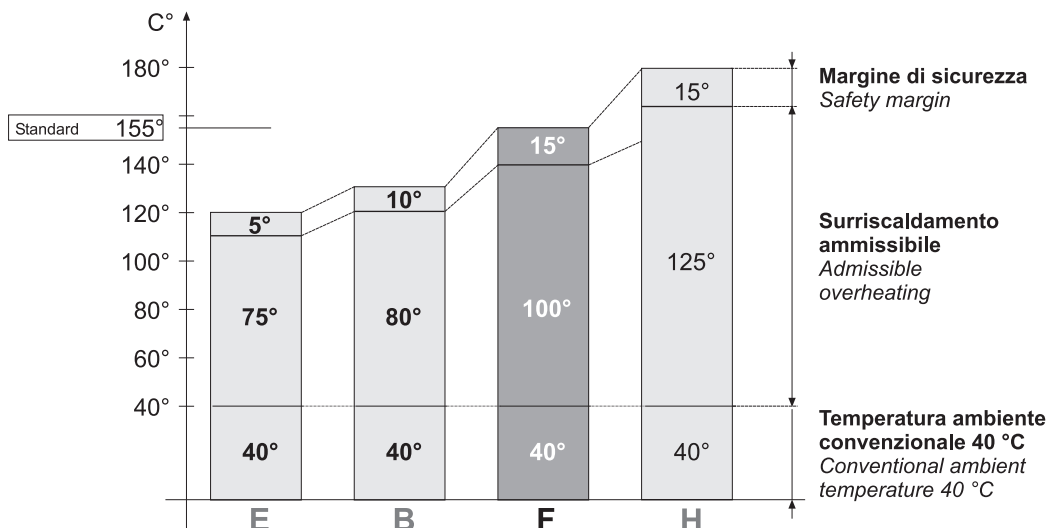



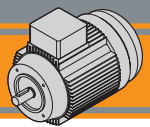

**Serie TS - Funzionamento a 60 Hz**

**Series TS - 60 Hz line power supply**

Velocità, coppia e potenza nominale nel funzionamento a 60 Hz varieranno come da tabella:

Speed, torque and rated power in 60 Hz operation is shown in the following table:

	50 Hz	60 Hz
<b>400 V</b>	Vedi dati tecnici / see technical data 	Velocità / speed $\approx + 20\%$ Coppia / torque $\approx -20\%$ Potenza / power $\approx$ invariata / the same
<b>480 V</b>	Non permesso / not allowed	Velocità / speed $\approx + 20\%$ Coppia / torque $\approx$ invariata / the same Potenza / power $\approx + 20\%$

**Dati pressacavi**

**Cable glands data**

TS	Pressacavi Cable glands
56	1-M16x1.5
63	1-M16x1.5
71	1-M20x1.5
80	1-M20x1.5
90	1-M20x1.5
100	2-M20x1.5

**Connessioni e collegamenti**

**Connection diagram**

**TS - 230 V - 50 Hz (275 V 60Hz) / 400 V - 50 Hz (480 V 60Hz)**

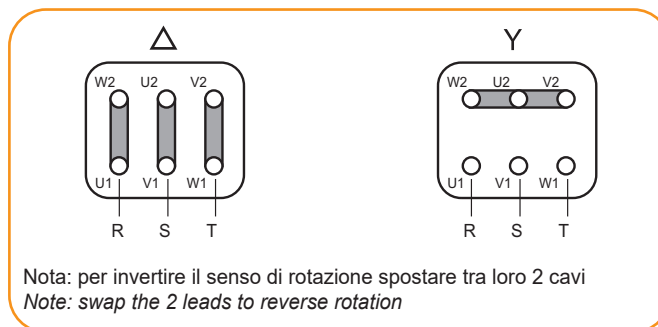

**Targhetta**

**Nameplate**

<b>TRANSTECNO</b> THE MODULAR GEARMOTOR www.transtecnio.com		<b>CE</b>	
		3 ASINCHR. MOTOR	
03 Type	$\mu$ F	VL	SN
	Serv. S 1	cos $\phi$	
50	kW	$\Delta$ 220 - 240/380 - 415 Y	V
Hz.	rpm		A
60	kW	$\Delta$ 264 - 288/456 - 498 Y	V
Hz.	rpm		A
IP 55	Is.cl. F		Kg.OP







**TRANSTECNO SRL  
HEADQUARTERS**

Company subject to the management  
and coordination of INTERPUMP GROUP SPA  
Via Caduti di Sabbiano, 11/D-E  
40011 Anzola dell'Emilia (BO)  
ITALY  
T+39 051 64 25 811  
F +39 051 73 49 43  
sales@transtecno.com  
www.transtecno.com



**HANGZHOU TRANSTECNO POWER  
TRANSMISSIONS CO LTD**  
No.4 Xiuyan Road Fengdu Industry Zone  
Pingyao Town Yuhang District  
Hangzhou City, Zhejiang Province  
311115 – CHINA  
T +86 571 86 92 02 60  
F +86 571 86 92 18 10  
info-china@transtecno.cn  
www.transtecno.cn



**MA TRANSTECNO S.A.P.I. DE C.V.**  
Av. Mundial # 176, Parque Industrial  
JM Apodaca, Nuevo León,  
C.P. 66600 – MÉXICO  
T +52 8113340920  
info@transtecno.com.mx  
www.transtecno.com.mx



**TRANSTECNO IBÉRICA  
THE MODULAR GEARMOTOR, S.A.**  
Carrer de la Ciència, 45  
08840 Viladecans (Barcelona) – SPAIN  
T +34 931 598 950  
info@transtecno.es  
www.transtecno.es



**TRANSTECNO B.V.**  
Siliciumweg 32  
3812 SX Amersfoort – NETHERLANDS  
T +31(0) 33 45 19 505  
F +31(0) 33 45 19 506  
info@transtecno.nl  
www.transtecno.nl

**www.transtecno.com**



**TRANSTECNO AANDRIJFTECHNIEK B.V.**  
Siliciumweg 32  
3812 SX Amersfoort – NETHERLANDS  
T +31 (0) 33 20 47 006  
info@transtecnoandrijftechnik.nl  
www.transtecnoandrijftechnik.nl



**TRANSTECNO USA**  
8 Creek Parkway,  
Boothwyn PA 19061-8136 - UNITED STATES  
T + 1 (610) 4970154  
F +1 (610) 497 6085

**TRANSTECNO USA – WEST COAST BRANCH**  
14561 Fryelands Blvd SE  
Monroe, WA 98272 – UNITED STATES  
T +1 360-863-1300  
F +1 360-863-1303  
usaoffice@transtecno.com  
www.transtecno.com



**TRANSTECNO CANADA**  
51 B Caldari Road Unit 10  
Vaughan, ON L4K 4G3 - CANADA  
T +1 905 761 0762  
F +1 905 761 9265  
canadaoffice@transtecno.com  
www.transtecno.com



**TRANSTECNO CHILE-PERU**  
Av. Los Libertadores 41  
Parque Industrial - Los Libertadores 16.500  
Santiago, Colina - CHILE  
T +56 2 29633870

Carretera Panamericana Sur KM 29.5,  
Interior I-3, Z.I. Lurin - PERU  
T +51 1 3546259 / +51 1 3434231  
chileoffice@transtecno.com  
www.transtecno.com



**TRANSTECNO INDIA**  
#6A, Sipcot Industrial complex, Phase-1, Elasagiri Road  
Hosur – 635126 Tamilnadu - INDIA  
T +91 4344 274434  
M +91 81443 88800

**TRANSTECNO INDIA – NORTH BRANCH**  
Plot No: 3 A, Sector 2, IIE, Sidcul, Pantnagar  
U.S. Nagar, Uttarakhand – 263153 - INDIA  
indiaoffice@transtecno.com  
www.transtecno.com



**SALES OFFICE BRAZIL**  
Rua Dr. Freire Alemão 155 / 402 - CEP. 90450-060  
Auxiliadora Porto Alegre RS - BRAZIL  
T +55 51 3251 5447  
F +55 51 3251 5447  
M +55 51 811 45 962  
braziloffice@transtecno.com  
www.transtecno.com.br



**SALES OFFICE OCEANIA**  
Unit 5, 12 Nyholt Drive, Yatala 4207  
Queensland - AUSTRALIA  
T +61 07 3800 0103  
M +61 04 38060997  
oceaniaoffice@transtecno.com  
www.transtecno.com.au



**SALES OFFICE SOUTH KOREA**  
772-41, Bongdong-ro, Bongdong-eup, Wanju-goon  
Chonbuk, 55313  
SOUTH KOREA  
T +82 70 8867 8897  
F +82 504 199 2107  
M +82 10 5094 2107  
koreaoffice@transtecno.com  
www.transtecno.com