

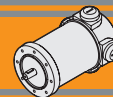

Neodymium

Motori elettrici CC
DC electric motors





	Indice	Index	Pag. Page
	Caratteristiche tecniche	<i>Technical Features</i>	B2
	Grado di protezione IP	<i>IP enclosures protection indexes</i>	B3
	Classe di isolamento termico	<i>Insulation class</i>	B3
	Tipi di servizio IEC	<i>IEC duty cycle ratings</i>	B3
ND120.120	Caratteristiche	<i>Features</i>	B4
ND120.240	Dimensioni	<i>Dimensions</i>	B4
	Prestazioni	<i>Performances</i>	B5
ND180.120	Caratteristiche	<i>Features</i>	B6
ND180.240	Dimensioni	<i>Dimensions</i>	B6
	Prestazioni	<i>Performances</i>	B7
	Legenda / Glossario dei grafici	<i>Key / Diagram Glossary</i>	B8
	Formule utili	<i>Useful formulas</i>	B8
	Freni	<i>Brakes</i>	B9
	Encoder	<i>Encoder</i>	B9

Questa sezione annulla e sostituisce ogni precedente edizione o revisione. Qualora questa sezione non Vi sia giunta in distribuzione controllata, l'aggiornamento dei dati ivi contenuto non è assicurato. **In tal caso la versione più aggiornata è disponibile sul nostro sito internet www.transtecno.com**

This section replaces any previous edition and revision. If you obtained this catalogue other than through controlled distribution channels, the most up to date content is not guaranteed. In this case the latest version is available on our web site www.transtecno.com

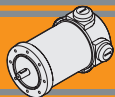

Caratteristiche tecniche

I magneti in Neodimio (NdFeB) fanno parte dei magneti a terre rare e sono attualmente i magneti più potenti in produzione. Dotati di alta forza coercitiva (resistenza alla smagnetizzazione) ed alto valore di saturazione magnetica, sono in grado di immagazzinare moltissima energia magnetica. Pertanto, i motori CC dotati di magneti in Neodimio forniscono alti valori di coppia pur in dimensioni ridotte, grazie all'alta densità di flusso del campo magnetico.

Le caratteristiche principali dei motori elettrici CC a magneti permanenti in neodimio ND sono:

- Campo magnetico generato da magneti permanenti in Neodimio (NdFeB)
- Costruzione tubolare senza ventilazione
- Disponibili in una grandezza diametro 65
- Alimentazione a bassa tensione 12 o 24 Vcc
- Potenza 160W e 250W S2
- Elevata coppia di spunto
- Maggiori coppie e potenze rispetto ai corrispettivi motori a magneti permanenti standard (a parità di dimensioni)
- Predisposizione encoder / freno

Classe di isolamento termico

Gli avvolgimenti del rotore sono soggetti a surriscaldamento, come pure altre parti del motore. Il grado di isolamento indica la massima temperatura ammissibile oltre la quale l'isolante della matassa e l'isolante di tutte le parti soggette ad elevato riscaldamento perde le caratteristiche di buon isolante, con pericolo di danneggiamento del motore.

Servizio

Rappresenta la relazione tra il tempo di lavoro ed il tempo di riposo del motore. Servizio continuo (S1) = funzionamento continuo del motore a pieno carico.

Servizio intermittente (S2, S3, etc...) = periodi alternati di lavoro e di riposo tali da raffreddare il motore. Dato un motore, la potenza espressa per servizio continuo è inferiore a quella per servizio intermittente.

Fattore di forma

Indica quanta componente spuria alternata è presente nella alimentazione CC del motore. Più alto è il fattore ed inferiore è l'efficienza del motore. Alimentatori ad SCR = F.F 1.40. Alimentazione pura da batteria = FF 1 Alimentazione da transistori (modulazione PWM) = FF 1.05.

Qualitativamente l'andamento della coppia (percentuale) rispetto al fattore di forma è indicato nel grafico seguente:

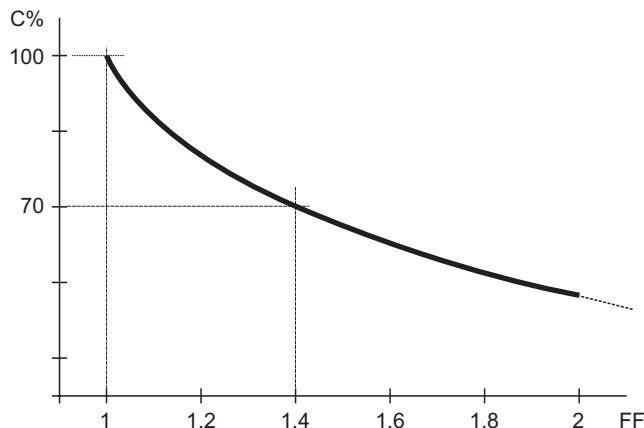

Technical features

Neodymium magnet (NdFeB) is a type of rare-earth magnet and is currently the strongest type of permanent magnets. Due to high coercivity resistance to being demagnetized and high saturation magnetization, they have potential for storing large amounts of magnetic energy. Therefore permanent Neodymium magnets DC motors can provide high torque in compact size due to the high density flux of magnet field.

The main features of ND neodymium permanent magnets DC electric motors range are:

- *Magnetic field generated by Neodymium (NdFeB) permanent magnets*
- *Tubular construction without fan*
- *Available in one size diameter 65*
- *Low voltage power supply 12 or 24 Vdc*
- *Power ratings available 160W and 250W S2*
- *High starting torque*
- *Higher torque and higher power than standard permanent magnet D.C. motors.*
- *Suitable for encoder / brake assembly*

Thermal insulation class

The windings of the rotor can overheat just like other parts of the motor too. The degree of insulation indicates the maximum allowable temperature above which the insulation of the windings, as well as that of all the parts which heat up to a high temperature, loses its insulating properties and the motor therefore risks being damaged.

Duty cycle

This represents the relationship between the time the motor operates and the time it remains stationary. Continuous operation (S1) = the motor operates non-stop under full load.

Intermittent operation (S2, S3, etc.) = alternating periods of work and rest so that the motor can cool down. The output power for continuous operation is lower than that for intermittent operation.

Form factor

It indicates how much spurious alternating current is present in the D.C. motor power supply. The higher the factor, the lower the motor's efficiency. SCR power supplies = F.F 1.40. Battery supply = FF 1 Transistor supply (PWM modulation) = FF 1.05.

The graph below indicates the torque trend (percentage) in relation to the form factor:

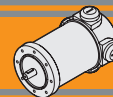

Grado di protezione IP

IP enclosures protection indexes

Indica il grado di isolamento meccanico del corpo motore.

Indicates the degree of mechanical insulation of the motor body.

1^a cifra: protezione alla penetrazione di corpi solidi.

1st figure: indicating level of protection against the penetration of solid bodies.

2^a cifra: protezione contro la penetrazione d'acqua.

2nd figure: indicating degree to which the motor is waterproof.

0	Non protetto / No protection	0	Non protetto / No protection
1	Protetto da corpi solidi superiori a Ø 50 mm. <i>Protected against solid matters (over Ø 50 mm)</i>	1	Protetto contro la caduta verticale di gocce d'acqua. <i>Protected against drops of water falling vertically</i>
2	Protetto da corpi solidi superiori a Ø 12 mm. <i>Protected against solid matters (over Ø 12 mm)</i>	2	Protetto contro la caduta verticale di gocce d'acqua con inclinazione max di 15° <i>Protected against drops of water falling up to 15°</i>
3	Protetto da corpi solidi superiori a Ø 2.5 mm. <i>Protected against solid matters (over Ø 2.5 mm)</i>	3	Protetto contro la pioggia. <i>Rain proof fixture</i>
4	Protetto da corpi solidi superiori a Ø 1 mm. <i>Protected against solid matters (over Ø 1 mm)</i>	4	Protetto contro gli spruzzi. <i>Splash proof fixture</i>
5	Protetto contro la polvere <i>Dust proof</i>	5	Protetto contro getti d'acqua <i>Water jet proof</i>
6	Totalmente protetto contro la polvere <i>Fully dust proof</i>	6	Protetto dalle ondate <i>Wave proof</i>
7	N.A.	7	Protetto contro immersione <i>Watertight immersion fixture.</i>
8	N.A.	8	Protetto contro immersione/sommersione prolungata <i>Watertight immersion fixture for a long time.</i>

Classe di isolamento termico

Insulation class

Classe / Class	Δ t °C Temp. ambiente: 40°C Ambient temperature: 40°C
A	65°C
B	90°C
F	115°C
H	140°C

Tipi di servizio IEC

IEC duty cycle ratings

S1	Servizio continuo. Funzionamento a carico costante per una durata sufficiente al raggiungimento dell'equilibrio termico.	Continuous duty. The motor works at a constant load for enough time to reach temperature equilibrium
S2	Servizio di durata limitata. Funzionamento a carico costante per una durata inferiore a quella necessaria al raggiungimento dell'equilibrio termico, seguito da un periodo di riposo tale da riportare il motore alla temperatura ambiente.	Short time duty. The motor works at a constant load, but not long enough to reach temperature equilibrium, and the rest periods are long enough for the motor to reach ambient temperature.
S3	Servizio periodico intermittente. Sequenze di cicli identici di marcia e di riposo a carico costante, senza raggiungimento dell'equilibrio termico. La corrente di spunto ha effetti trascurabili sul surriscaldamento del motore.	Intermittent periodic duty. Sequential, identical run and rest cycles with constant load. Temperature equilibrium is never reached. Starting current has little effect on temperature rise.
S4	Servizio periodico intermittente con avviamento. Sequenza di cicli di funzionamento identici di avviamento, marcia e riposo a carico costante, senza raggiungimento dell'equilibrio termico. La corrente di spunto ha effetti sul riscaldamento del motore.	Intermittent periodic duty with starting. Sequential identical start, run and rest cycles with constant load. Temperature equilibrium is not reached, but starting current affects temperature rise.
S5	Servizio periodico intermittente con frenatura elettrica. Sequenza di cicli di funzionamento identici di avviamento, marcia a carico costante, frenatura elettrica e riposo, senza raggiungimento dell'equilibrio termico.	Intermittent periodic duty with electric braking. Sequential, identical cycles of starting, running at constant load, electric braking and rest. Temperature equilibrium is not reached.
S6	Servizio periodico ininterrotto con carico intermittente. Sequenza di cicli di lavoro identici con carico costante e senza carico. Non ci sono periodi di riposo.	Continuous operation with intermittent load. Sequential, identical cycles of running with constant load and running with no load. No rest periods.
S7	Servizio periodico ininterrotto con frenatura elettrica. Sequenza di cicli di funzionamento identici di avviamento, marcia a carico costante e frenatura elettrica, senza periodi di riposo.	Continuous operation with electric braking. Sequential, identical cycles of starting, running at constant load and electric braking. No rest periods.
S8	Servizio periodico ininterrotto con variazioni di carico e di velocità. Sequenza di cicli identici di avviamento, marcia a carico costante e velocità definita, seguiti da marcia a carico costante differente e velocità differente dalla precedente. Non ci sono periodi di riposo.	Continuous operation with periodic changes in load and speed. Sequential, identical, duty cycles of start, run at constant load and given speed, then run at other constant loads and speeds. No rest periods.

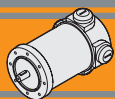

ND120.120 - ND120.240

Caratteristiche

Features

Costruzione	Tubolare, senza ventilazione
Grandezza	Ø 65 mm
Potenza	160 W S2 (120 W S1)
Magneti	4 magneti in terre rare
Supporti	Cuscinetti a sfera
Fori di montaggio	8
Alimentazione	Bassa tensione, 12 o 24 Vcc
Spazzole	N° 4 di composto grafite-rame
Cavo di alimentazione	Lunghezza: 1000 mm
Bisporgenza	Standard

Construction	Tubular, without fan
Size	Ø 65 mm
Power	160 W S2 (120 W S1)
Magnets	4 rare earth magnets
Bearings	Ball bearings
Mounting holes	8
Power supply	Low voltage, 12 or 24 Vdc
Brushes	4 brushes made of graphite/copper composite
Electric cable	Length: 1000 mm
Rear Shaft	Standard

Tipo Type	S	Pn [W]	V [V]	I [A]	IC	FF	Mn [Nm]	n ₁ [min ⁻¹]	IP	Kg
ND120.120	S1	120	12	13.9	F	1	0.38	3000	20	1.6
	S2 20'	160		19			0.51			
ND120.240	S1	120	24	6.9			0.38			
	S2 20'	160		9.0			0.51			

Dimensioni

Dimensions

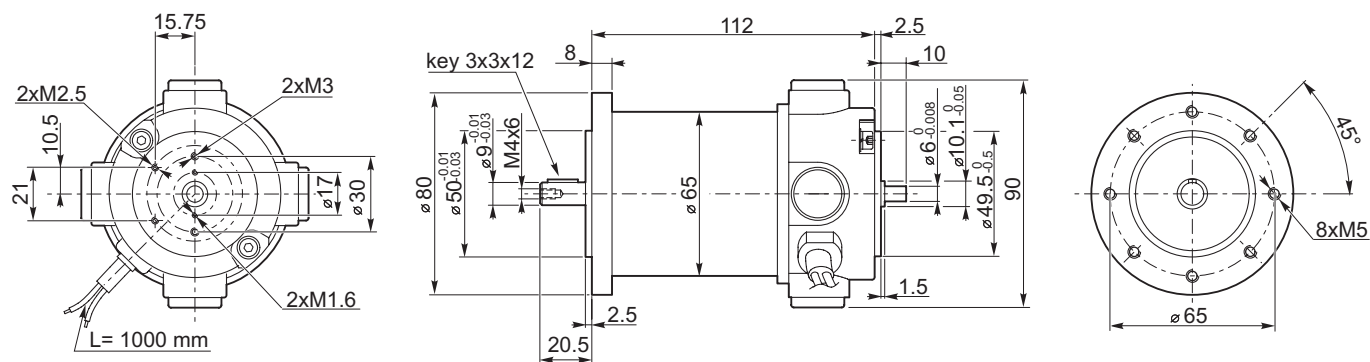

Freno / Brake → B9

Encoder → B9

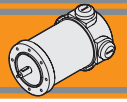

ND120.120 - ND120.240

Prestazioni

Performances

ND120.120

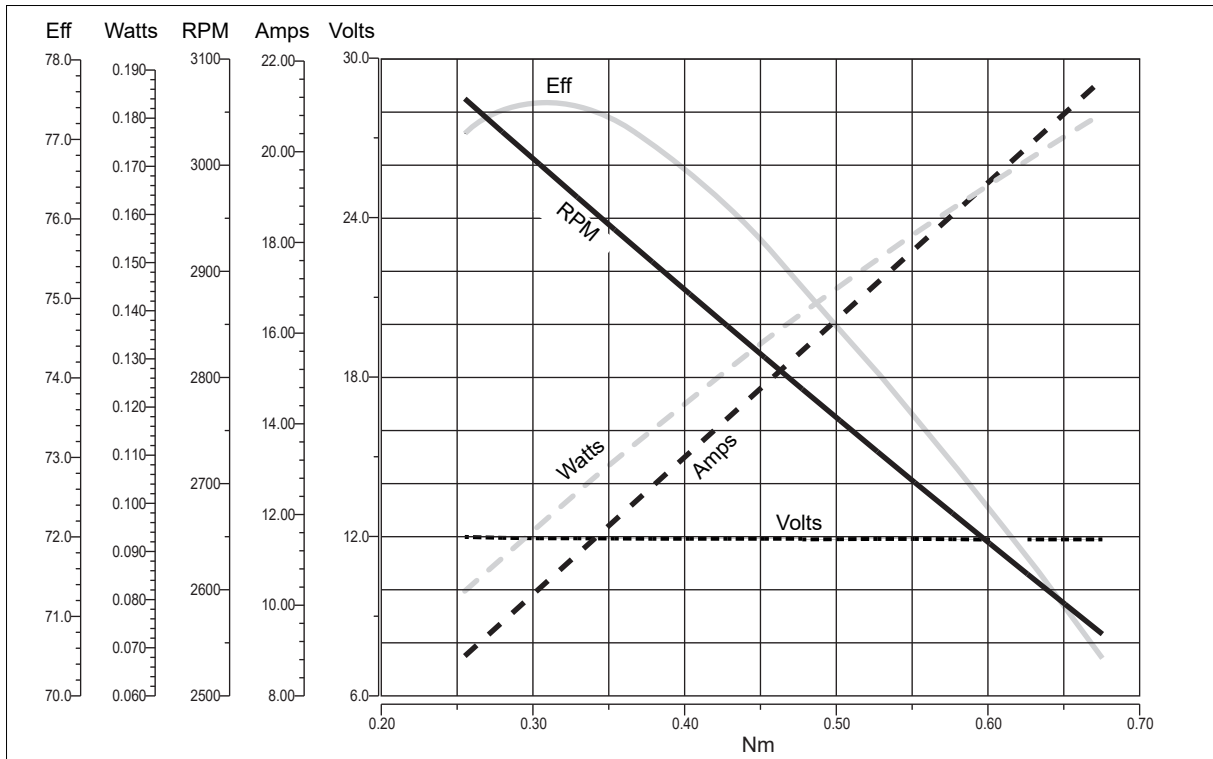

ND120.240

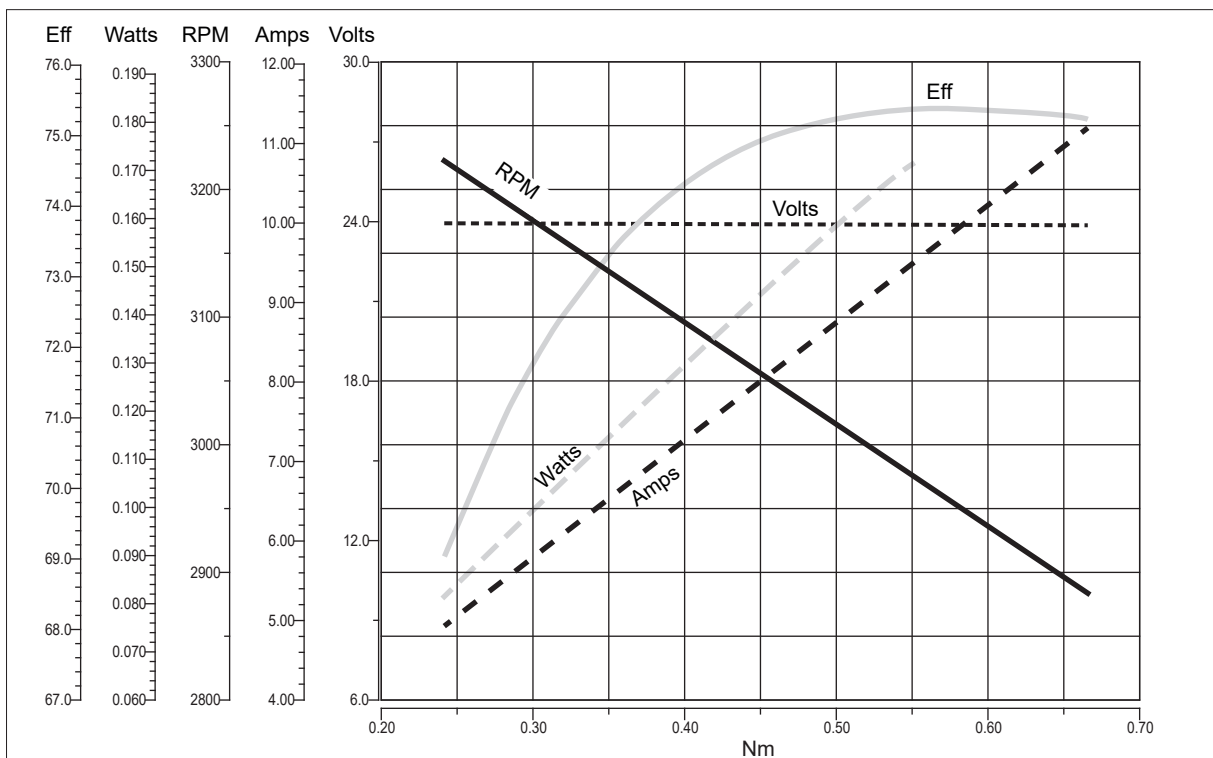

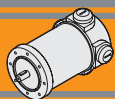

ND180.120 - ND180.240

Caratteristiche

Features

Costruzione	Tubolare, senza ventilazione
Grandezza	Ø 65 mm
Potenza	250 W S2 (180 W S1)
Magneti	4 magneti in terre rare
Supporti	Cuscinetti a sfera
Fori di montaggio	8
Alimentazione	Bassa tensione, 12 o 24 Vcc
Spazzole	N° 4 di composto grafite-rame
Cavo di alimentazione	Lunghezza: 1000 mm
Bisporgenza	Standard

Construction	Tubular, without fan
Size	Ø 65 mm
Power	250 W S2 (180 W S1)
Magnets	4 rare earth magnets
Bearings	Ball bearings
Mounting holes	8
Power supply	Low voltage, 12 or 24 Vdc
Brushes	4 brushes made of graphite/copper composite
Electric cable	Length: 1000 mm
Rear Shaft	Standard

Tipo Type	S	Pn [W]	V [V]	I [A]	IC	FF	Mn [Nm]	n ₁ [min ⁻¹]	IP	Kg
ND180.120	S1	180	12	20	F	1	0.57	3000	20	1.95
	S2 20'	250		30			0.80			
ND180.240	S1	180	24	10						
	S2 20'	250		14			0.57			
							0.80			

Dimensioni

Dimensions

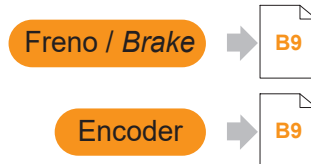
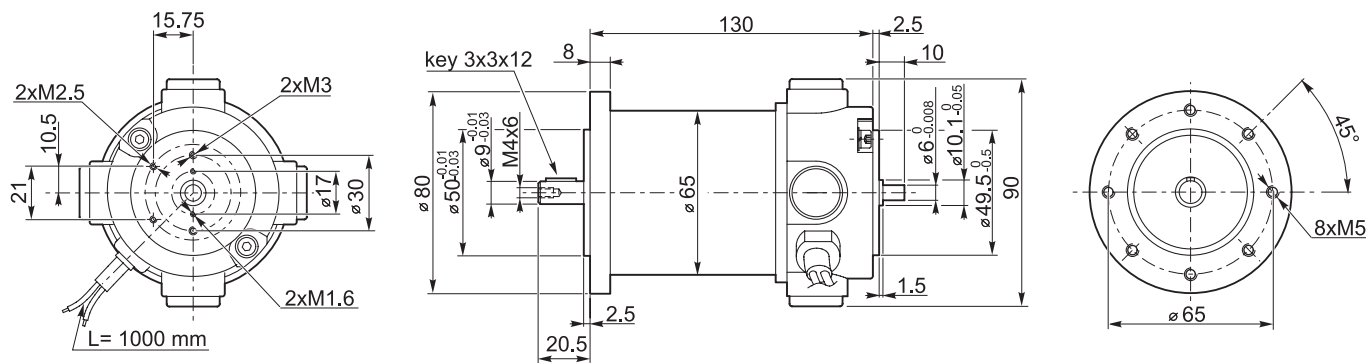

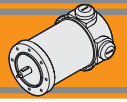

ND180.120 - ND180.240

Prestazioni

Performances

ND180.120

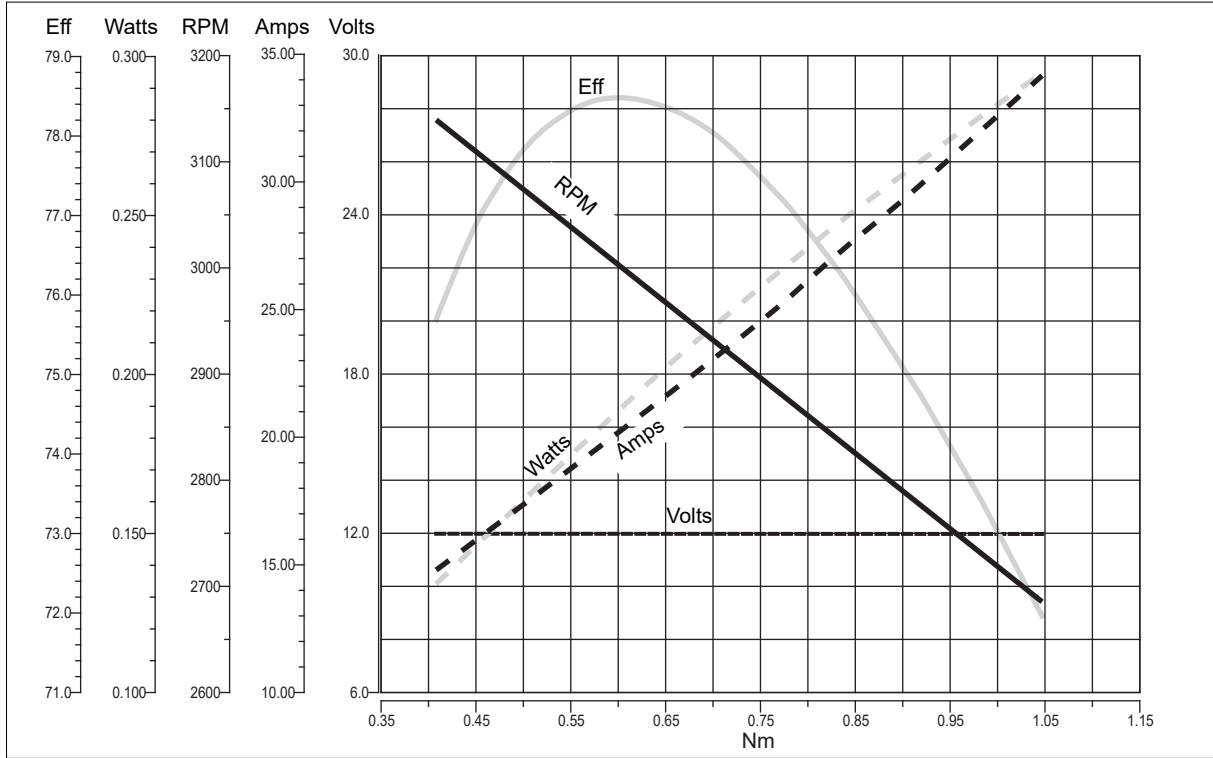

ND180.240

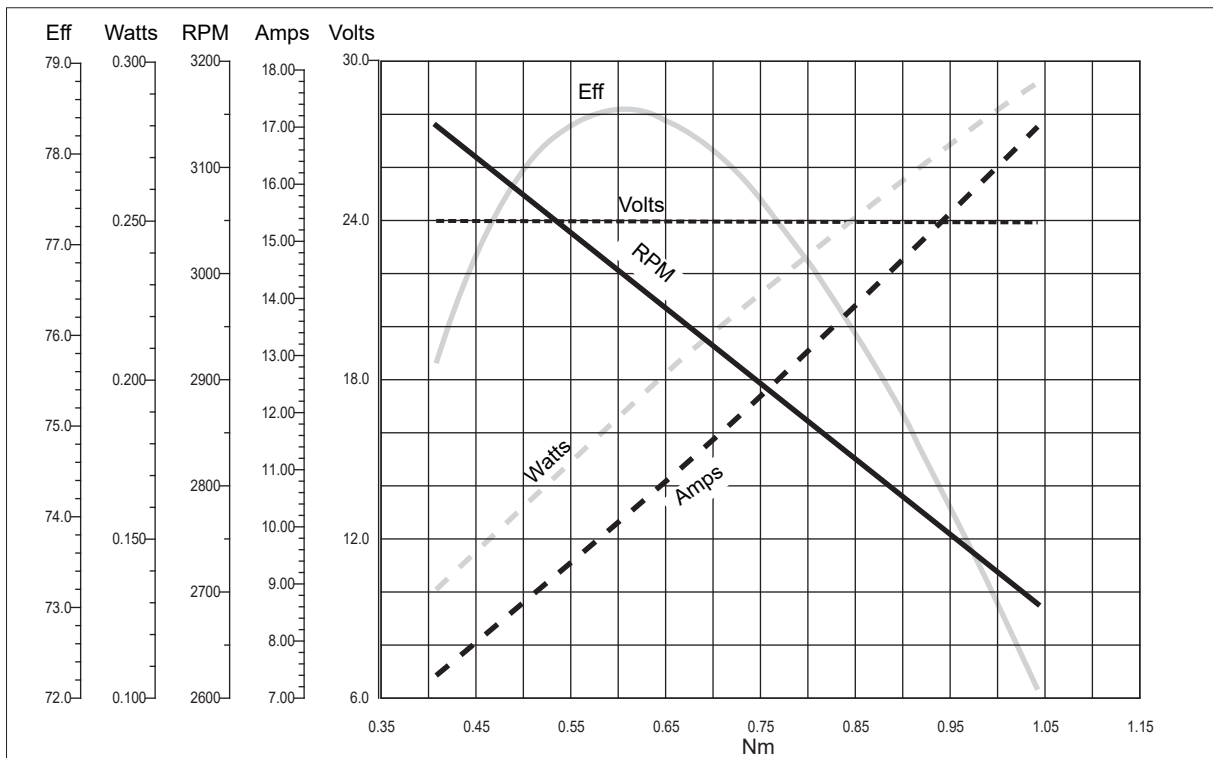

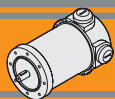

Legenda / Glossario dei grafici

Key / Diagram Glossary

Dato un motore in CC, la velocità di rotazione è funzione lineare della coppia; così pure la corrente assorbita è una funzione lineare della coppia. Velocità e corrente variano in maniera sensibile al variare del carico.

With a DC motor, the rotational speed is a linear function of the torque. In the same way, the absorbed current is also a linear function of the torque. Speed and current change a lot against applied torque.

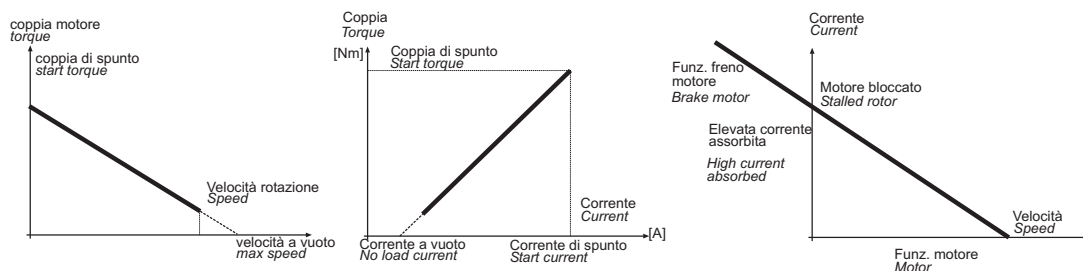

La potenza utile (potenza all'albero) si ricava dalla formula:

$$P_n [W] = M_n \cdot S = \frac{2\pi}{60} \cdot n_1 \cdot M_n$$

The output power is calculated using the formula:

$$P_n [W] = M_n \cdot S = \frac{2\pi}{60} \cdot n_1 \cdot M_n$$

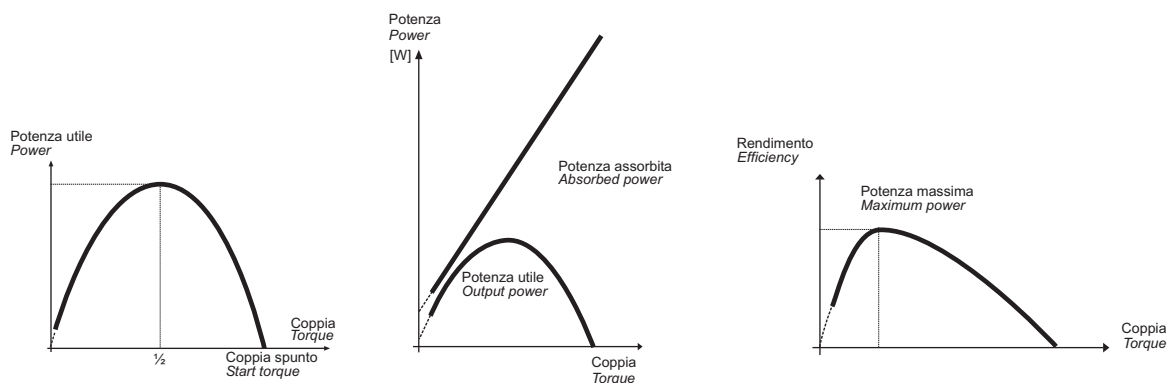

Poiché la tensione di alimentazione è costante mentre la corrente è linearmente crescente al crescere della coppia, l'andamento della potenza assorbita è una retta crescente. Dal rapporto tra la potenza meccanica e la potenza assorbita si ottiene il grafico dell'efficienza.

Since the supply voltage is constant, whereas the current increases in a linear manner as the torque increases, the absorbed power trend is a straight line going up. Efficiency is shown from the ratio between the output power and the absorbed power.

Formule utili

Useful formulas

$$\eta = \frac{P_n}{P_a}$$

$$P_a = V \cdot I$$

$$P_n = V \cdot I \cdot \eta$$

$$P_n = M_n \cdot S_v$$

$$S_v = \frac{n_1}{9.55}$$

$$\eta = \frac{P_n}{P_a}$$

$$P_a = V \cdot I$$

$$P_n = V \cdot I \cdot \eta$$

$$P_n = M_n \cdot S_v$$

$$S_v = \frac{n_1}{9.55}$$

$$[HP] \cdot 746 = [W]$$

Esempio 2 HP = circa 1500 W.

$$[HP] \cdot 746 = [W]$$

Example 2 HP = approx. 1500 W.

S	—	Servizio	<i>Duty</i>
P_n	[W]	Potenza in uscita	<i>Rated power</i>
P_a	[W]	Potenza assorbita	<i>Absorbed power</i>
M_n	[Nm]	Coppia nominale	<i>Rated torque</i>
V	[V]	Tensione	<i>Voltage</i>
I	[A]	Corrente assorbita	<i>Absorbed current</i>
n₁	[min ⁻¹]	Numero giri motore	<i>Motor speed</i>
S_v	[rad/s]	Velocità angolare	<i>Angular speed</i>
IC	—	Classe d'isolamento termico	<i>Thermal insulation class</i>
FF	—	Fattore di forma	<i>Form factor</i>
IP	—	Classe di protezione	<i>Protection class</i>
η	—	Rendimento	<i>Efficiency</i>
Kg	—	Peso	<i>Weight</i>

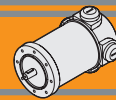

Freno

Brake

ND...BR Freno / Brake

ND...BRL Freno con leva di sblocco/ Brake with hand release

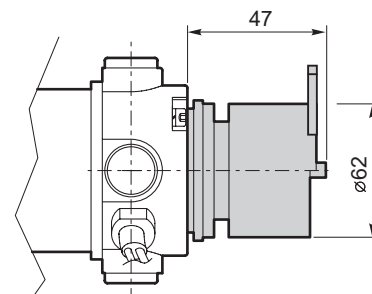
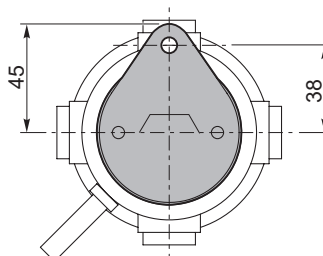
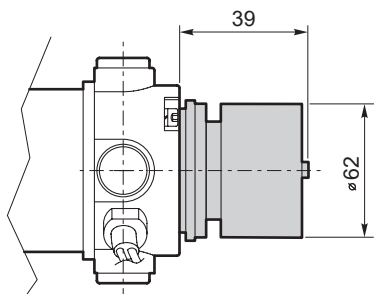

	Pn [W]	V [V]	Mn [Nm]	n ₁ [min ⁻¹]
Caratteristiche del freno / Break features	14	12	1.8	3000
		24		

Encoder

Encoder

ND...ME22

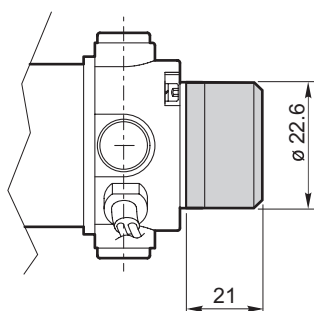

Nota: Fornito con cavo lungo 300 mm

Note: Supplie with cavle 300 mm long

Risoluzione Encoder (CPR) / Encoder Resolution (CPR)	Numero di canali / Number of channels	Tensione d'alimentazione / Power supply
001	2	5 VdC - TTL
100		
300		

Per risoluzioni encoder non standard, si prega di contattare il nostro Servizio Tecnico.

For non-standard encoder resolution, please contact our Technical Department.

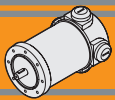

ND

Motori elettrici CC
DC Electric motors

Note/Notes

**TRANSTECNO SRL
HEADQUARTERS**

Company subject to the management
and coordination of INTERPUMP GROUP SPA
Via Caduti di Sabbiuno, 11/D-E
40011 Anzola dell'Emilia (BO)
ITALY
T+39 051 64 25 811
F +39 051 73 49 43
sales@transtecno.com
www.transtecno.com



TRANSTECNO®
the modular gearmotor

MEMBER OF INTERPUMP GROUP

**HANGZHOU TRANSTECNO POWER
TRANSMISSIONS CO LTD**
No.4 Xiuyan Road Fengdu Industry Zone
Pingyao Town Yuhang District
Hangzhou City, Zhejiang Province
311115 – CHINA
T +86 571 86 92 02 60
info-china@transtecno.cn
www.transtecno.cn



MA TRANSTECNO S.A.P.I. DE C.V.
Av. Mundial # 176, Parque Industrial
JM Apodaca, Nuevo León,
C.P. 66600 - MÉXICO
T +52 8113340920
info@transtecno.com.mx
www.transtecno.com.mx



**TRANSTECNO IBÉRICA
THE MODULAR GEARMOTOR, S.A.**
Carrer de la Ciència, 45
08840 Viladecans (Barcelona) - SPAIN
T +34 931 598 950
info@transtecno.es
www.transtecno.es



TRANSTECNO B.V.
Siliciumweg 32
3812 SX Amersfoort - NETHERLANDS
T +31(0) 33 45 19 505
info@transtecno.nl
www.transtecno.nl



TRANSTECNO AANDRIJFTECHNIEK B.V.
Siliciumweg 32
3812 SX Amersfoort - NETHERLANDS
T +31(0) 33 20 47 006
info@transtecnoaandrijftechniek.nl
www.transtecnoaandrijftechniek.nl



TRANSTECNO USA
8 Creek Parkway,
Boothwyn PA 19061-8136 - UNITED STATES
T + 1 (610) 4970154

TRANSTECNO USA – WEST COAST BRANCH
14561 Fryelands Blvd SE
Monroe, WA 98272 - UNITED STATES
T +1 360-863-1300
usaoffice@transtecno.com
www.transtecno.com



TRANSTECNO CANADA
51 B Caldari Road Unit 10
Vaughan, ON L4K 4G3 - CANADA
T +1 905 761 0762
canadaoffice@transtecno.com
www.transtecno.com



TRANSTECNO CHILE-PERU
Av. Los Libertadores 41
Parque Industrial - Los Libertadores 16.500
Santiago, Colina - CHILE
T +56 2 29633870

Carretera Panamericana Sur KM 29.5,
Interior I-3, Z.I. Lurin - PERU
T +51 1 3546259 / + 51 1 3434231
chileoffice@transtecno.com
www.transtecno.com



TRANSTECNO INDIA
#6A, Sipcot Industrial complex, Phase-1, Elasagiri Road
Hosur – 635126 Tamilnadu - INDIA
T +91 4344 274434
M +91 81443 88800

TRANSTECNO INDIA – NORTH BRANCH
Plot No: 3 A, Sector 2, IIE, Sidcul, Pantnagar
U.S. Nagar, Uttarakhand – 263153 - INDIA
indiaoffice@transtecno.com
www.transtecno.com



TRANSTECNO BRAZIL
Rua Gilberto de Zorzi, 525 Forqueta - CEP. 95115-730
CX Postal 3544 Caxias do Sul RS – BRAZIL

TRANSTECNO BRAZIL – SÃO PAULO BRANCH
R. Mafalda Barnabe Soliane, 314 – CEP. 13347-610
Indaiatuba, São Paulo - BRAZIL
T +55 19 3437 2520

TRANSTECNO BRAZIL – PORTO ALEGRE BRANCH
Rua Dr. Freire Alemão 155 / 402 - CEP. 90450-060
Auxiliadora Porto Alegre RS - BRAZIL
T +55 51 3251 5447
M +55 51 811 45 962
braziloffice@transtecno.com
www.transtecno.com.br



INTERPUMP ANTRIEBSTECHNIK - TRANSTECNO
Vertriebsbüro Stuttgart - GERMANY
T +49 (0)171 4781909
germanoffice@transtecno.com
www.transtecno.com



SALES OFFICE OCEANIA
Unit 5, 12 Nyholt Drive, Yatala 4207
Queensland - AUSTRALIA
T +61 07 3800 0103
M +61 04 38060997



UNIT 9, 94 Boundary Rd, Sunshine West 3020
Victoria - AUSTRALIA
T +61 9312 4722
oceaniaoffice@transtecno.com
www.transtecno.com.au



SALES OFFICE SOUTH KOREA
772-41, Bongdong-ro, Bongdong-eup, Wanju-goon
Chonbuk, 55313
SOUTH KOREA
T +82 70 8867 8897
M +82 10 5094 2107
koreaoffice@transtecno.com
www.transtecno.com

www.transtecno.com