

TRANSTECNO[®]
the modular gearmotor

EC IP66

EC IP66



Ferrite



Motori elettrici CC IP66
IP66 DC electric motors





	Indice	Index	Pag. Page
EC070.120.66	Caratteristiche	<i>Features</i>	12
EC070.240.66	Dimensioni	<i>Dimensions</i>	12
	Prestazioni	<i>Performances</i>	13
EC100.120.66	Caratteristiche	<i>Features</i>	14
EC100.240.66	Dimensioni	<i>Dimensions</i>	14
	Prestazioni	<i>Performances</i>	14
EC180.120.66	Caratteristiche	<i>Features</i>	16
EC180.240.66	Dimensioni	<i>Dimensions</i>	16
	Prestazioni	<i>Performances</i>	16
EC250.120.66	Caratteristiche	<i>Features</i>	18
EC250.240.66	Dimensioni	<i>Dimensions</i>	18
	Prestazioni	<i>Performances</i>	19
EC350.120.66	Caratteristiche	<i>Features</i>	110
EC350.240.66	Dimensioni	<i>Dimensions</i>	110
	Prestazioni	<i>Performances</i>	111
EC600.120.66	Caratteristiche	<i>Features</i>	112
EC600.240.66	Dimensioni	<i>Dimensions</i>	112
	Prestazioni	<i>Performances</i>	113

Questa sezione annulla e sostituisce ogni precedente edizione o revisione. Qualora questa sezione non Vi sia giunta in distribuzione controllata, l'aggiornamento dei dati ivi contenuto non è assicurato. **In tal caso la versione più aggiornata è disponibile sul nostro sito internet www.transtecno.com**

*This section replaces any previous edition and revision. If you obtained this catalogue other than through controlled distribution channels, the most up to date content is not guaranteed. **In this case the latest version is available on our web site www.transtecno.com***

**EC IP66**Motori elettrici CC
DC Electric motors**EC070.120.66 - EC070.240.66****Caratteristiche****Features**

Costruzione	Tubolare, senza ventilazione
Grandezza	Ø 65 mm
Potenza	100 W S2 (70 W S1)
Magneti	2
Supporti	Cuscinetti a sfera
Fori di montaggio	4
Alimentazione	Bassa tensione, 12 o 24 Vcc
Spazzole	N° 2 interne di composto grafite-rame
Cavo di alimentazione	Lunghezza: 1000 mm

Construction	Tubular, without fan
Size	Ø 65 mm
Power	100 W S2 (70 W S1)
Magnets	2
Bearings	Ball bearings
Mounting holes	4
Power supply	Low voltage, 12 or 24 Vdc
Brushes	2 inside brushes made of graphite/copper composite
Electric cable	Length: 1000 mm

Tipo Type	S	Pn [W]	V [V]	I [A]	IC	FF	Mn [Nm]	n ₁ [min ⁻¹]	IP	Kg
EC070.12E	S1	70	12	8.4	F	1	0.22	3000	66	1.7
	S2 30'	100		11.8			0.31			
EC070.24E	S1	70	24	4.2						
	S2 30'	100		5.9			0.31			

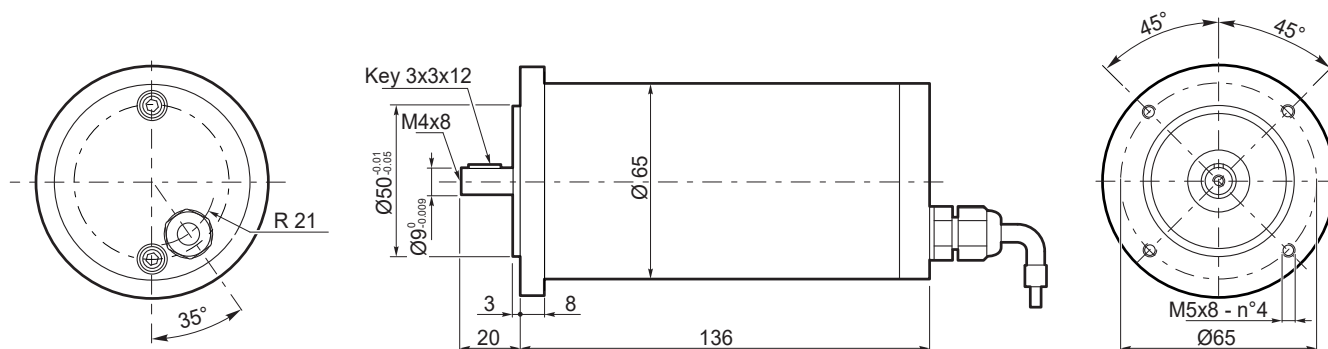
Dimensioni**Dimensions****EC070.120.66**
EC070.240.66



EC070.120.66 - EC070.240.66

Prestazioni

Performances

EC070.120.66

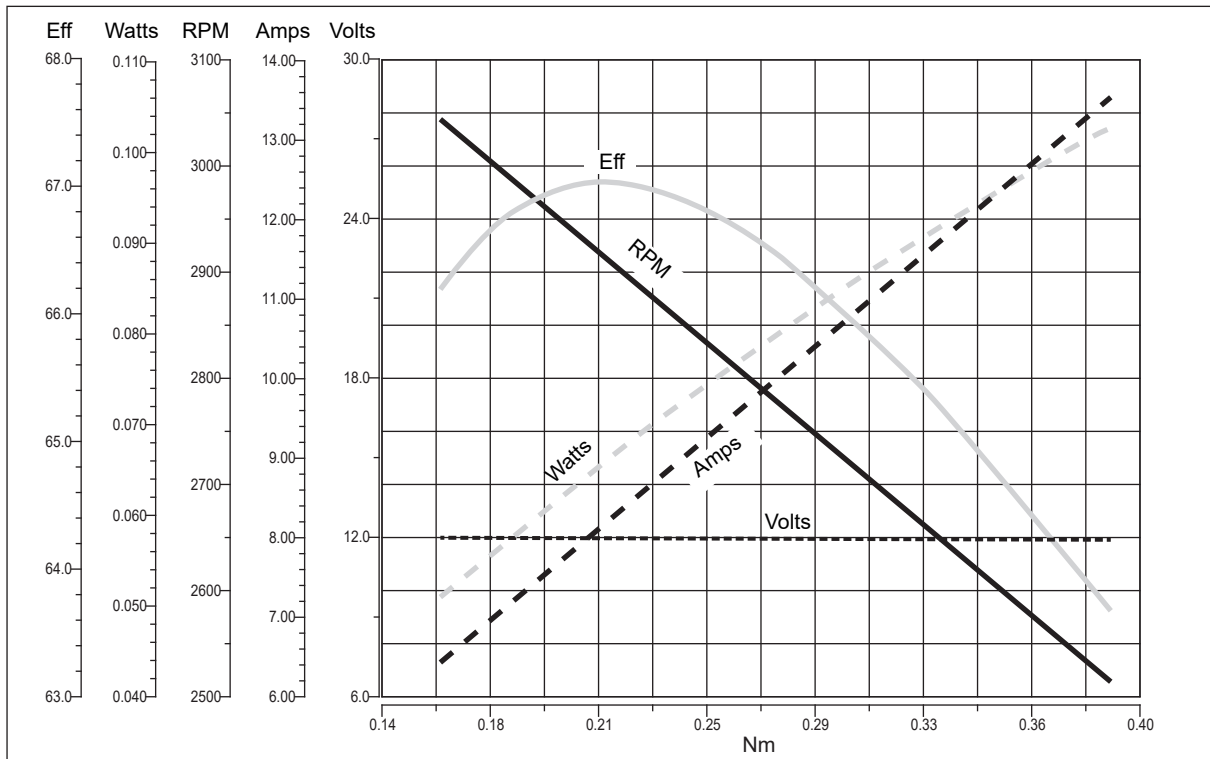

EC IP66

EC070.240.66

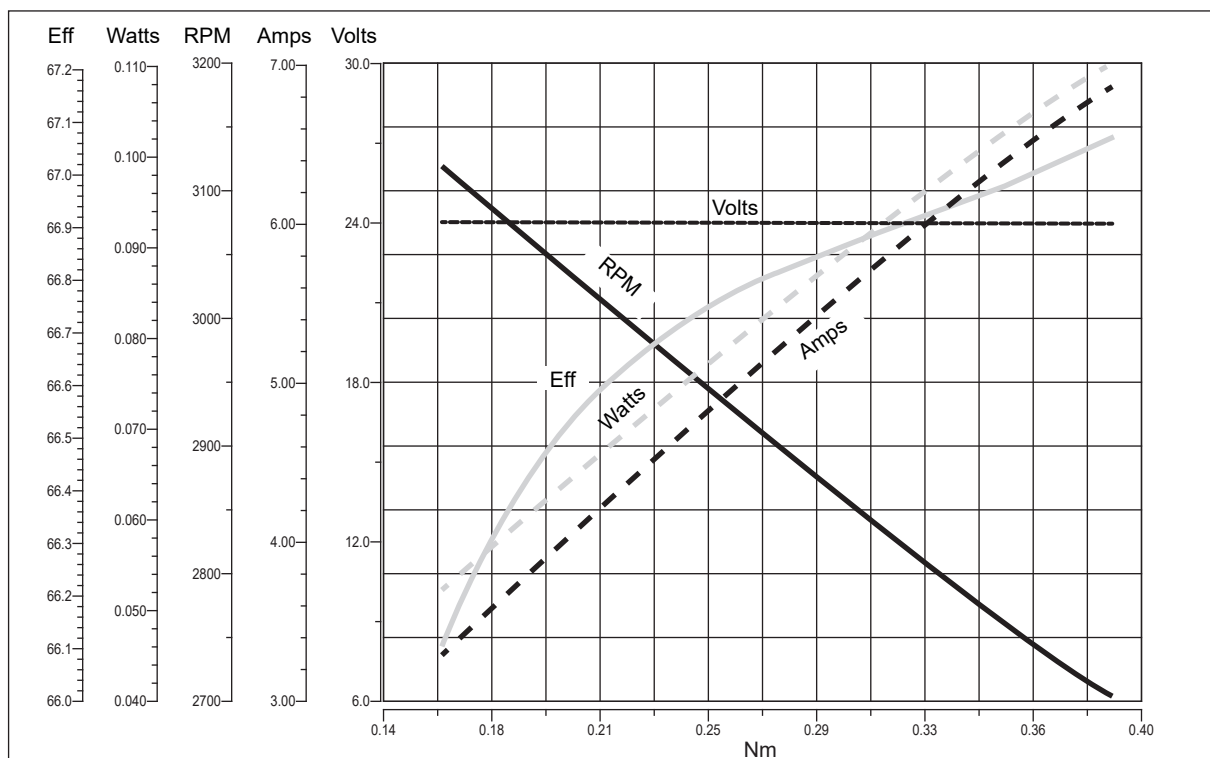



EC100.120.66 - EC100.240.66

Caratteristiche

Features

Costruzione	Tubolare, senza ventilazione
Grandezza	Ø 80 mm
Potenza	140 W S2 (100 W S1)
Magneti	2
Supporti	Cuscinetti a sfera
Fori di montaggio	4
Alimentazione	Bassa tensione, 12 o 24 Vcc
Cavo di alimentazione	Lunghezza: 1000 mm

Construction	Tubular, without fan
Size	Ø 80 mm
Power	140 W S2 (100 W S1)
Magnets	2
Bearings	Ball bearings
Mounting holes	4
Power supply	Low voltage, 12 or 24 Vdc
Electric cable	Length: 1000 mm

Tipo Type	S	Pn [W]	V [V]	I [A]	IC	FF	Mn [Nm]	n ₁ [min ⁻¹]	IP	Kg
EC100.120.66	S1	100	12	12	F	1	0.31	3000	66	2.7
	S2 25'	140		16.8			0.43			
EC100.240.66	S1	100	24	6			0.31			
	S2 25'	140		8.4			0.43			

Dimensioni

Dimensions

EC100.120.66
EC100.240.66

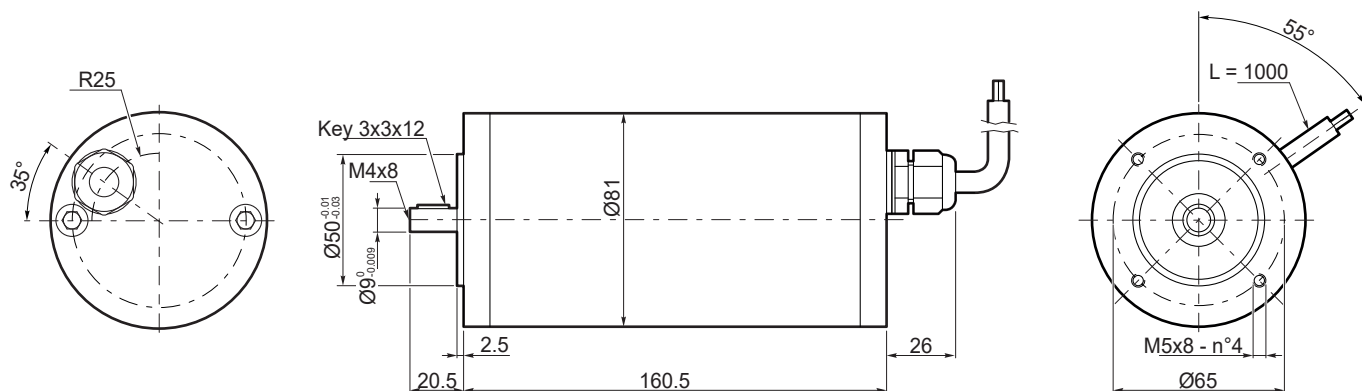



EC100.120.66

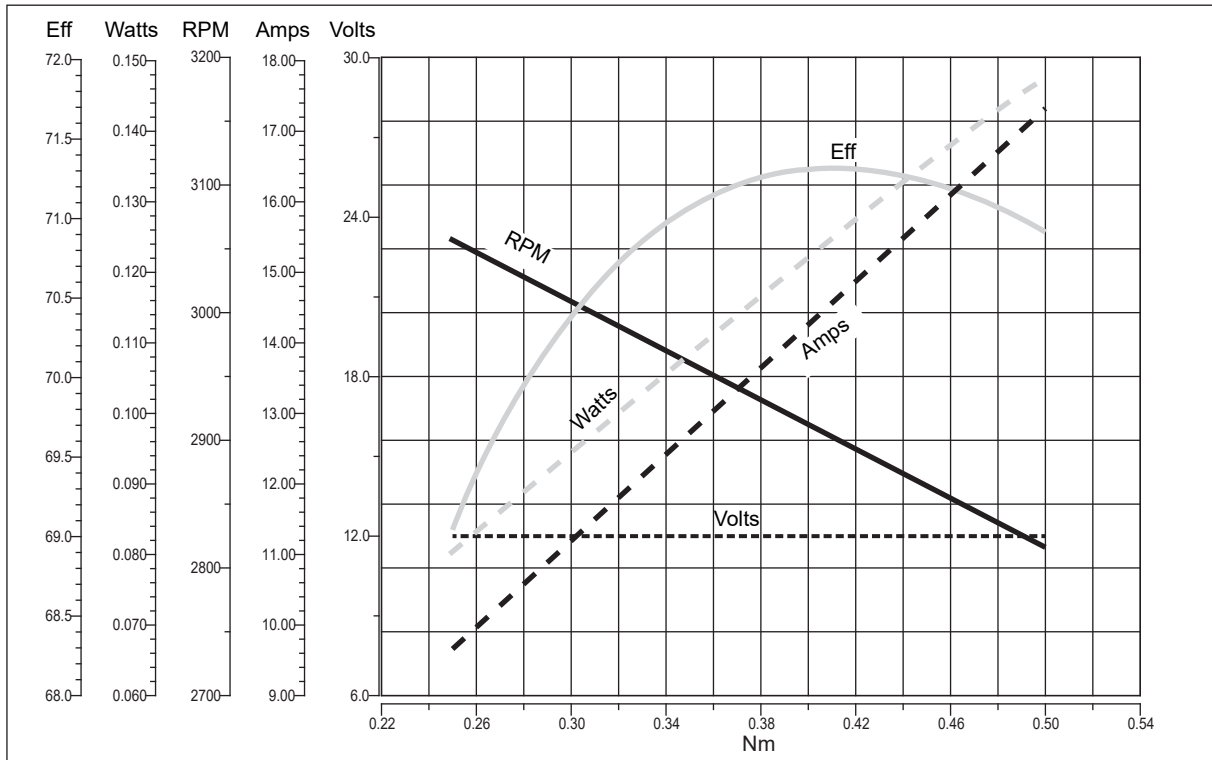

EC IP66

EC100.240.66

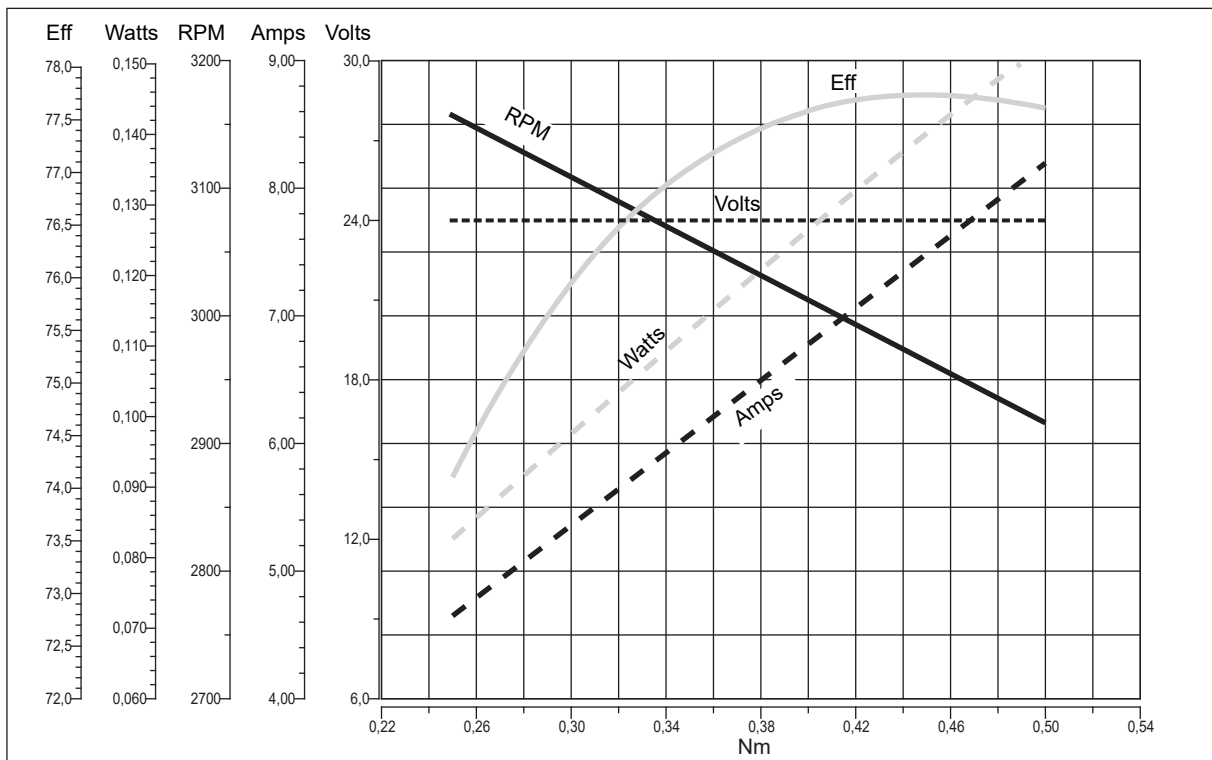



EC180.120.66 - EC180.240.66

Caratteristiche

Features

Costruzione	Tubolare, senza ventilazione
Grandezza	Ø 80 mm
Potenza	250 W S2 (180 W S1)
Magneti	2
Supporti	Cuscinetti a sfera
Fori di montaggio	4
Alimentazione	Bassa tensione, 12 o 24 Vcc
Cavo di alimentazione	Lunghezza: 1000 mm

Construction	Tubular, without fan
Size	Ø 80 mm
Power	250 W S2 (180 W S1)
Magnets	2
Bearings	Ball bearings
Mounting holes	4
Power supply	Low voltage, 12 or 24 Vdc
Electric cable	Length: 1000 mm

Tipo Type	S	Pn [W]	V [V]	I [A]	IC	FF	Mn [Nm]	n ₁ [min ⁻¹]	IP	Kg
EC180.120.66	S1	180	12	21.5	F	1	0.57	3000	66	3.4
	S2 25'	250		30			0.8			
EC180.240.66	S1	180	24	10.8			0.57			
	S2 25'	250		15			0.8			

Dimensioni

Dimensions

EC180.120.66
EC180.240.66

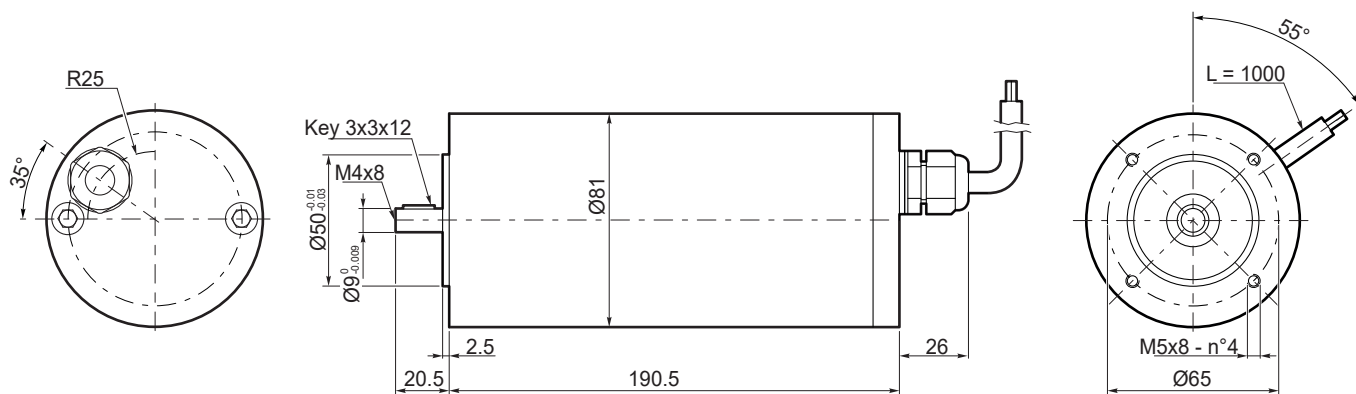



EC180.120.66

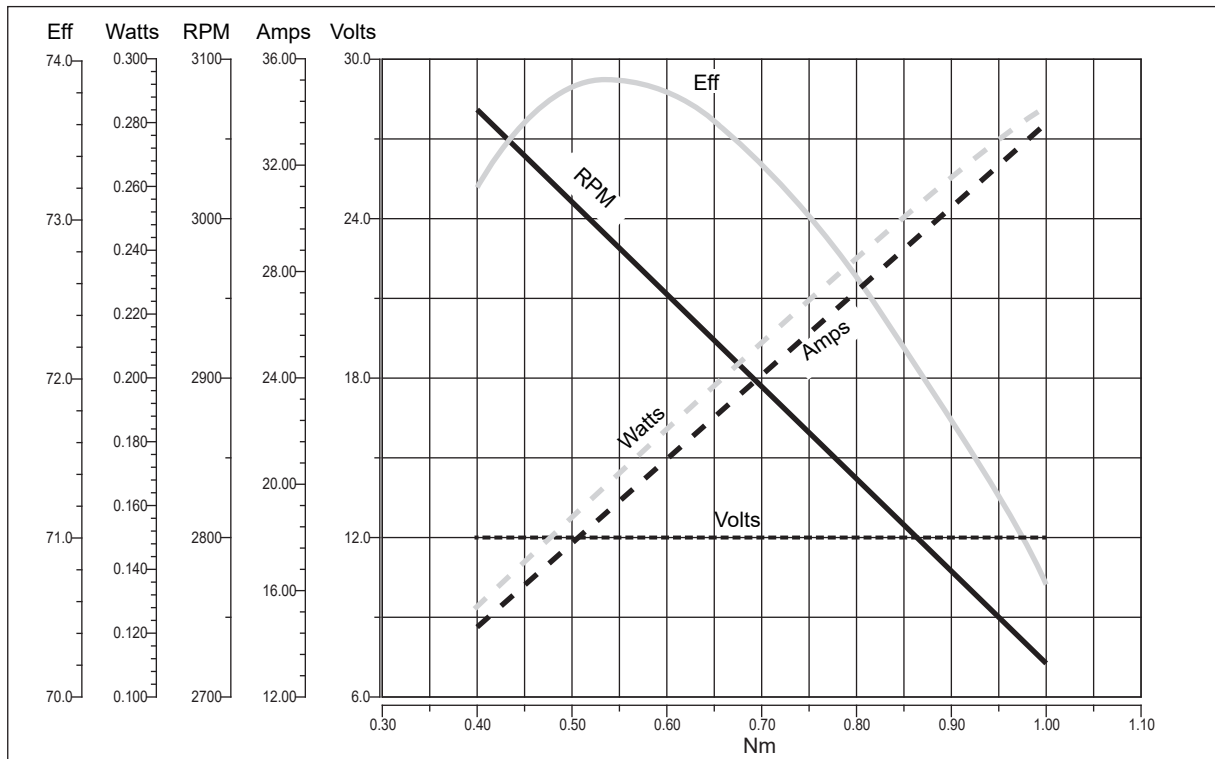

EC IP66

EC180.240.66

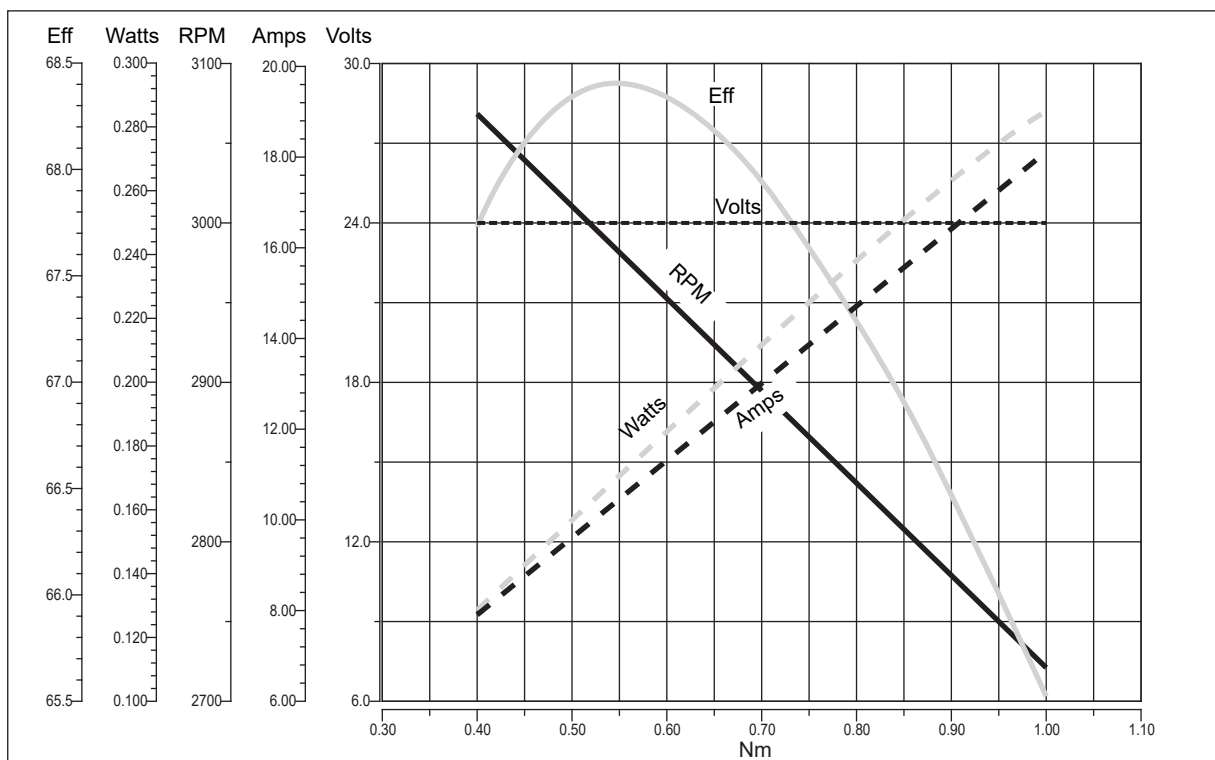



EC250.120.66 - EC250.240.66

Caratteristiche

Features

Costruzione	Tubolare, senza ventilazione
Grandezza	Ø 104 mm
Potenza	350 W S2 (250 W S1)
Magneti	4
Supporti	Cuscinetti a sfera
Fori di montaggio	8
Alimentazione	Bassa tensione, 12 o 24 Vcc
Terminali	2 con doppio dado di fissaggio

Construction	Tubular, without fan
Size	Ø 104 mm
Power	350 W S2 (250 W S1)
Magnets	4
Bearings	Ball bearings
Mounting holes	8
Power supply	Low voltage, 12 or 24 Vdc
Leads terminals	2, with double nut

Tipo Type	S	Pn [W]	V [V]	I [A]	IC	FF	Mn [Nm]	n ₁ [min ⁻¹]	IP	Kg
EC250.120.66	S1	250	12	30	F	1	0.8	3000	66	4.15
	S2 25'	350		38.5			1.12			
EC250.240.66	S1	250	24	15			0.8			
	S2 25'	350		20.5			1.12			

Dimensioni

Dimensions

EC250.120.66

EC250.240.66

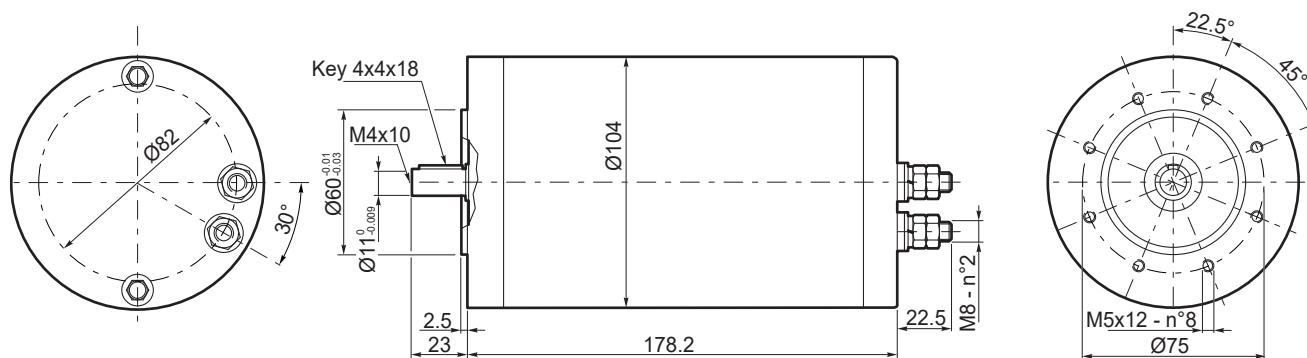



EC250.120.66

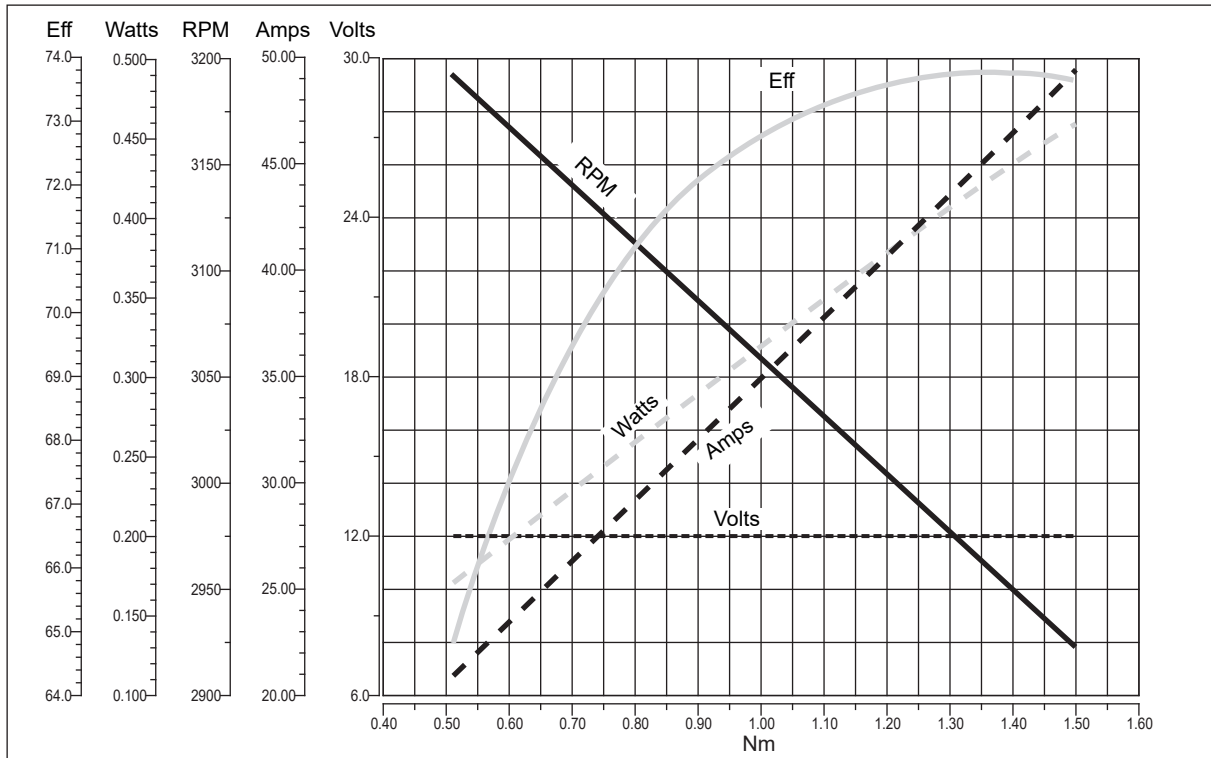

EC IP66

EC250.240.66

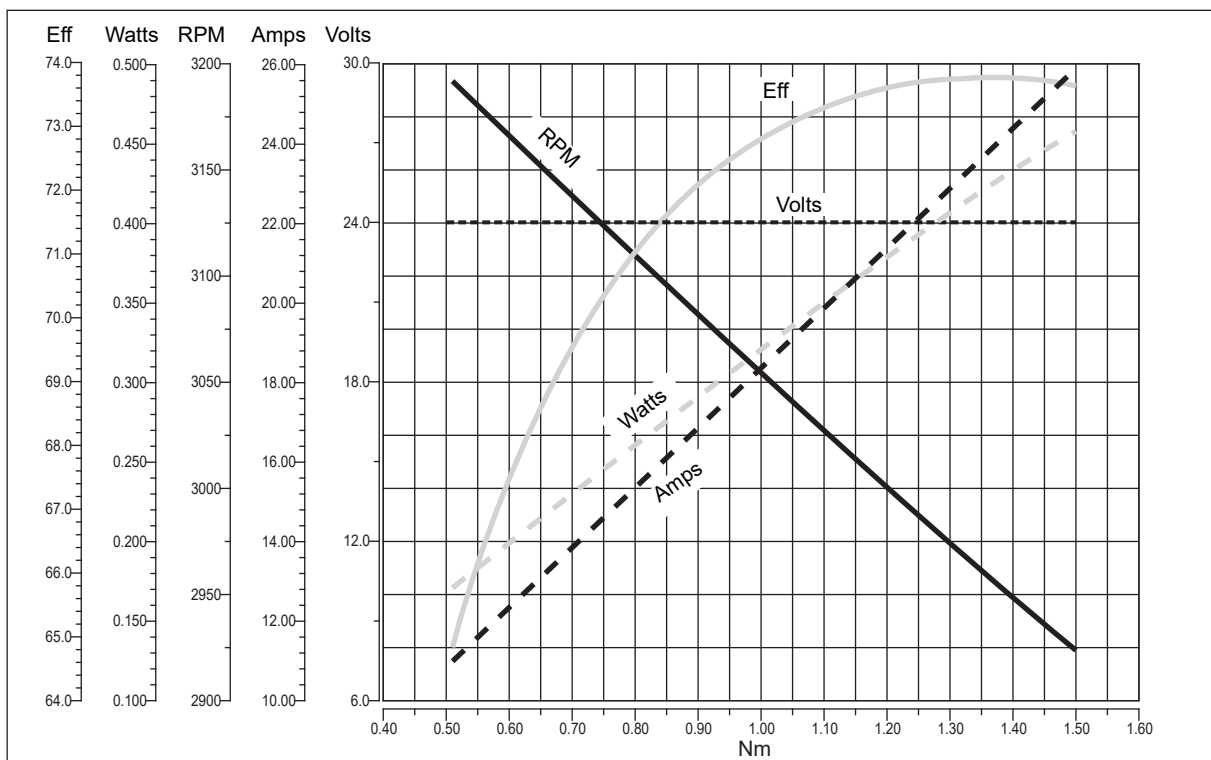



EC350.120.66 - EC350.240.66

Caratteristiche

Features

Costruzione	Tubolare, senza ventilazione
Grandezza	Ø 110 mm
Potenza	500 W S2 (350 W S1)
Magneti	4
Supporti	Cuscinetti a sfera
Fori di montaggio	8
Alimentazione	Bassa tensione, 12 o 24 Vcc
Terminali	2 con dadi di fissaggio

Construction	Tubular, without fan
Size	Ø 110 mm
Power	500 W S2 (350 W S1)
Magnets	4
Bearings	Ball bearings
Mounting holes	8
Power supply	Low voltage, 12 or 24 Vdc
Leads terminals	2, with double nut

Tipo Type	S	Pn [W]	V [V]	I [A]	IC	FF	Mn [Nm]	n ₁ [min ⁻¹]	IP	Kg
EC350.120.66	S1	350	12	42	F	1	1.12	3000	66	5.1
	S2 30'	500		58.8			1.57			
EC350.240.66	S1	350	24	21			1.12			5.3
	S2 30'	500		29.4			1.57			

Dimensioni

Dimensions

EC350.120.66
EC350.240.66

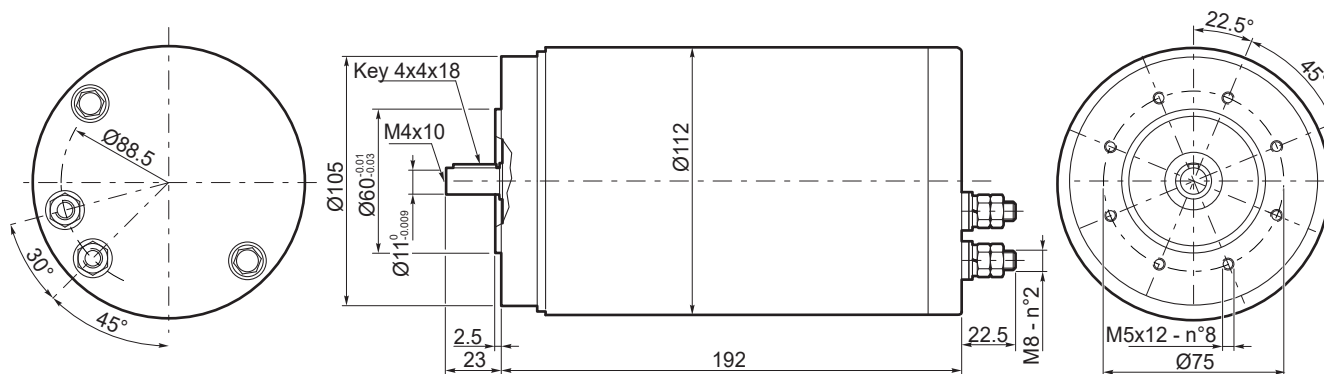



EC350.120.66

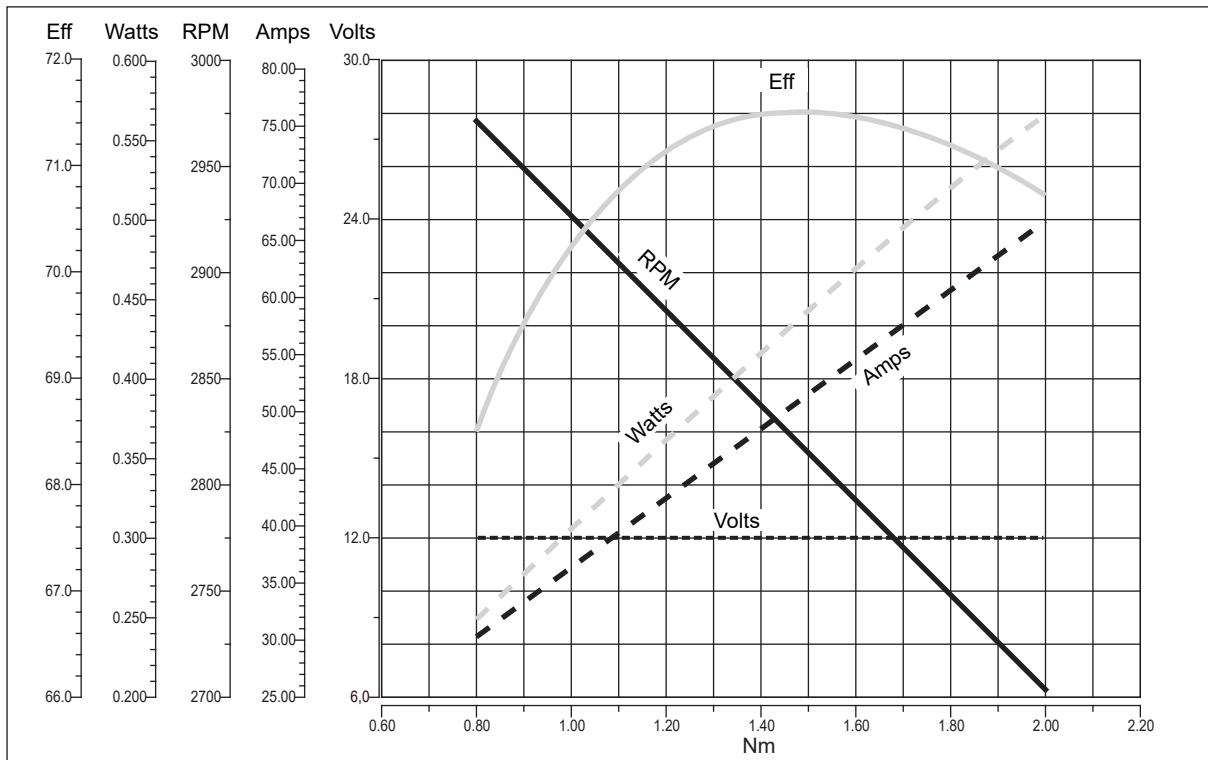

EC IP66

EC350.240.66

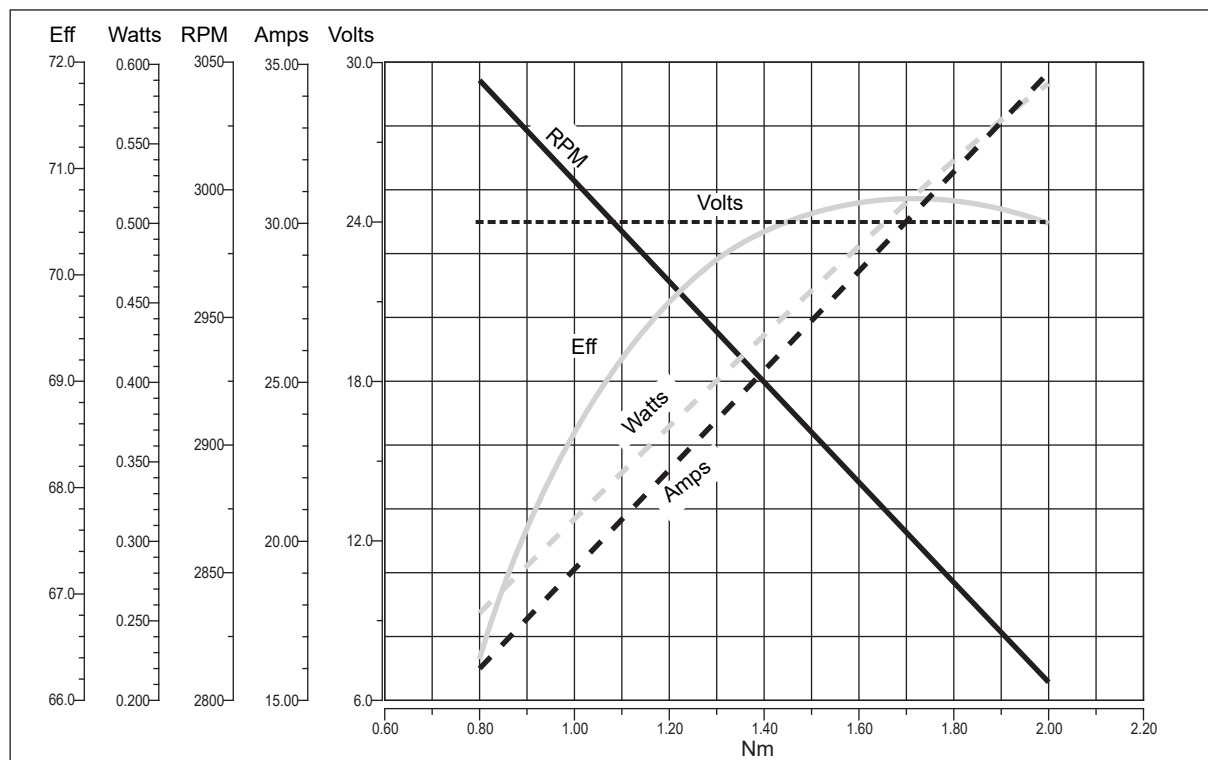

**EC IP66**Motori elettrici CC
DC Electric motors**EC600.120.66 - EC600.240.66****Caratteristiche****Features**

Costruzione	Tubolare, senza ventilazione
Grandezza	Ø 110 mm
Potenza	800 W S2 (600 W S1)
Magneti	4
Supporti	Cuscinetti a sfera
Fori di montaggio	8
Alimentazione	Bassa tensione, 12 o 24 Vcc
Terminali	2 con doppio dado di fissaggio

Construction	Tubular, without fan
Size	Ø 110 mm
Power	800 W S2 (600 W S1)
Magnets	4
Bearings	Ball bearings
Mounting holes	8
Power supply	Low voltage, 12 or 24 Vdc
Leads terminals	2, with double nut

Tipo Type	S	Pn [W]	V [V]	I [A]	IC	FF	Mn [Nm]	n ₁ [min ⁻¹]	IP	Kg
EC600.120.66	S1	600	12	71	F	1	1.91	3000	66	6.6
	S2 30'	800		94.4			2.54			
EC600.240.66	S1	600	24	35.5			1.91			7.1
	S2 30'	800		47.2			2.54			

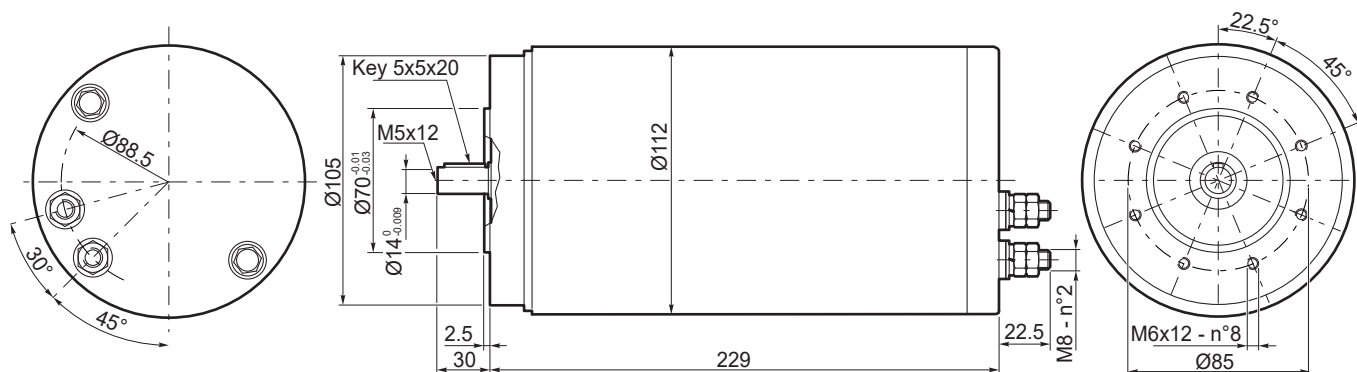
Dimensioni**Dimensions****EC600.120.66****EC600.240.66**



EC600.120.66

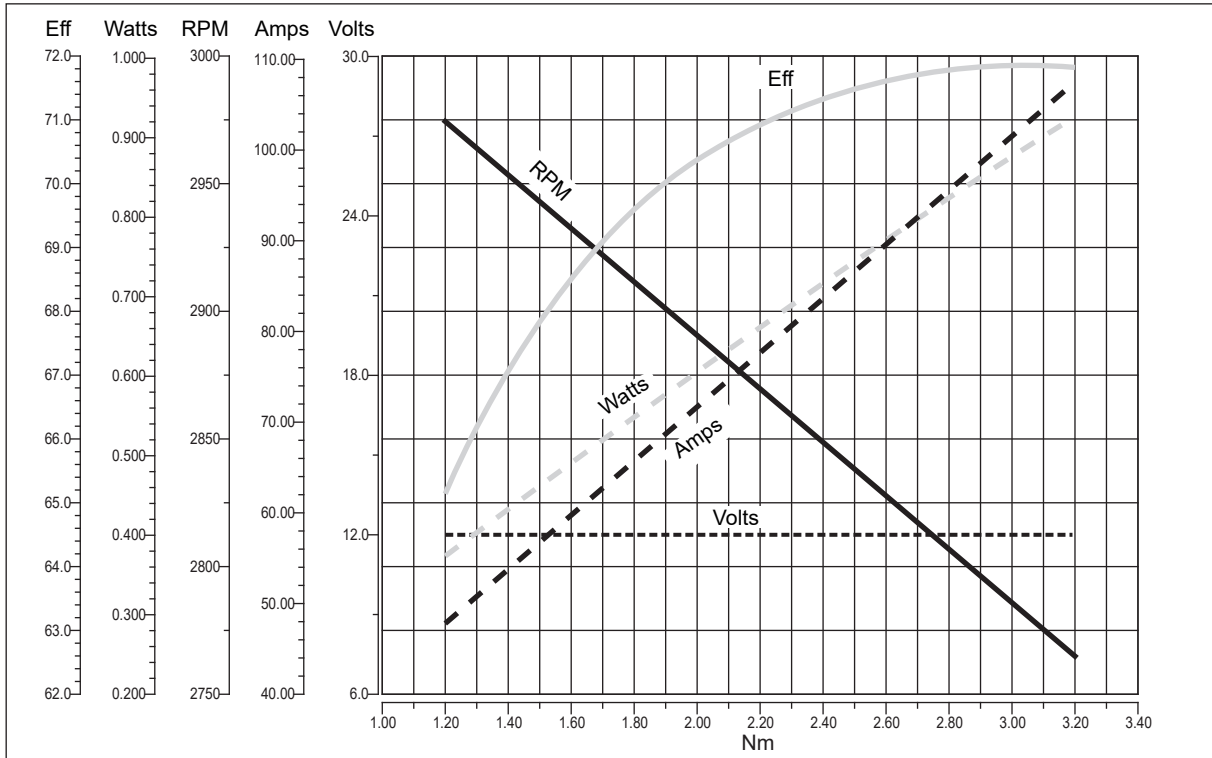

EC IP66

EC600.240.66

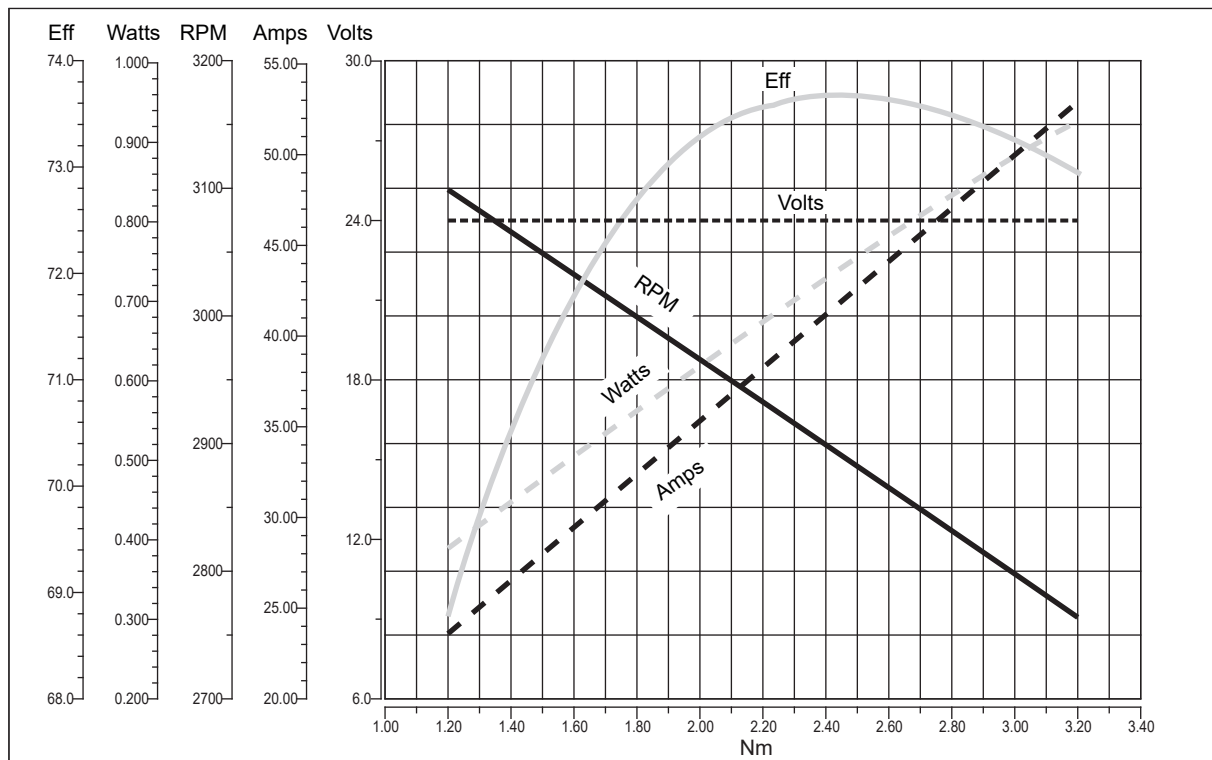



MA TRANSTECNO S.A.P.I. DE C.V.
 Av. Mundial # 176, Parque Industrial
 JM Apodaca, Nuevo León,
 C.P. 66600
 MÉXICO
 T +52 8113340920
 info@transtecno.com.mx
 www.transtecno.com.mx



TRANSTECNO SRL
 Via Caduti di Sabbiano, 11/D-E
 40011 Anzola dell'Emilia (BO)
 ITALY
 T+39 051 64 25 811
 F +39 051 73 39 04
 sales@transtecno.com
 www.transtecno.com



HANGZHOU TRANSTECNO POWER TRANSMISSIONS CO LTD
 No.4 Xiuyan Road Fengdu Industry Zone
 Pingyao Town Yuhang District
 Hangzhou City, Zhejiang Province
 311115 – CHINA
 T +86 571 86 92 02 60
 F +86 571 86 92 18 10
 info-china@transtecno.com
 www.transtecno.cn



TRANSTECNO U.S.A. LLC
 5440 S.W. 156th Place Miami,
 FL 33185 - USA
 Tel: +1 (305) 220-4423
 Fax: +1 (305) 220-5945
 usaoffice@transtecno.com



TRANSTECNO B.V.
 Ind. terrein Wieken/Vinkenhof
 De Stuwdam,43
 3815 KM Amersfoort - NETHERLANDS
 Tel: +31(0) 33 45 19 505
 Fax: +31(0) 33 45 19 506
 info@transtecno.nl
 www.transtecno.nl



SALES OFFICE INDIA
 A/10, Anagha, S.N. Road, Mulund (W) Mumbai
 400080 - INDIA
 Tel: +91 9820614698
 Fax-Italy: +39 051 733 904
 indiaoffice@transtecno.com



SALES OFFICE BRAZIL
 Rua Dr. Freire Alemão 155 / 402 - CEP. 90450-060
 Auxiliadora Porto Alegre RS - BRAZIL
 Tel: +55 51 3251 5447
 Fax: +55 51 3251 5447
 Mobile: +55 51 811 45 962
 braziloffice@transtecno.com
 www.transtecno.com.br



**TRANSTECNO IBÉRICA
 THE MODULAR GEARMOTOR, S.A.**
 C/Enginy, 2 Nave 6 - 08850 Gavà (Barcelona) - SPAIN
 Tel: +34 931 598 950
 info@transtecno.es
 www.transtecno.es



SALES OFFICE SOUTH KOREA
 D-304 Songdo BRC Smart Valley 30, Songdomirae-ro,
 Yeonsu-gu, Incheon, 406-840 - KOREA
 Tel: +82 70 8288 2107
 Fax: +82 32 815 2107
 Mobile: +82 10 5094 2107
 koreaoffice@transtecno.com



SALES OFFICE FRANCE
 12 Impasse des Mûriers
 38300 Ruy - FRANCE
 Tel: +33 (0) 6 85 12 09 87
 Fax-Italy: +39 051 733 904
 franceoffice@transtecno.com
 www.transtecno.fr



SALES OFFICE OCEANIA
 44 Northview drive, Sunshine west 3020
 Victoria - AUSTRALIA
 Ph +61 03 9312 4722
 Fax +61 03 9312 4714
 Mobile: +61 0438060997
 oceaniaoffice@transtecno.com
 www.transtecno.com.au

TRANSTECNO®
 the modular gearmotor

www.transtecno.com