



TRANSTECNO[®]

the modular gearmotor

TRANSTECNO GROUP

Company profile

2018

Transtecno Group

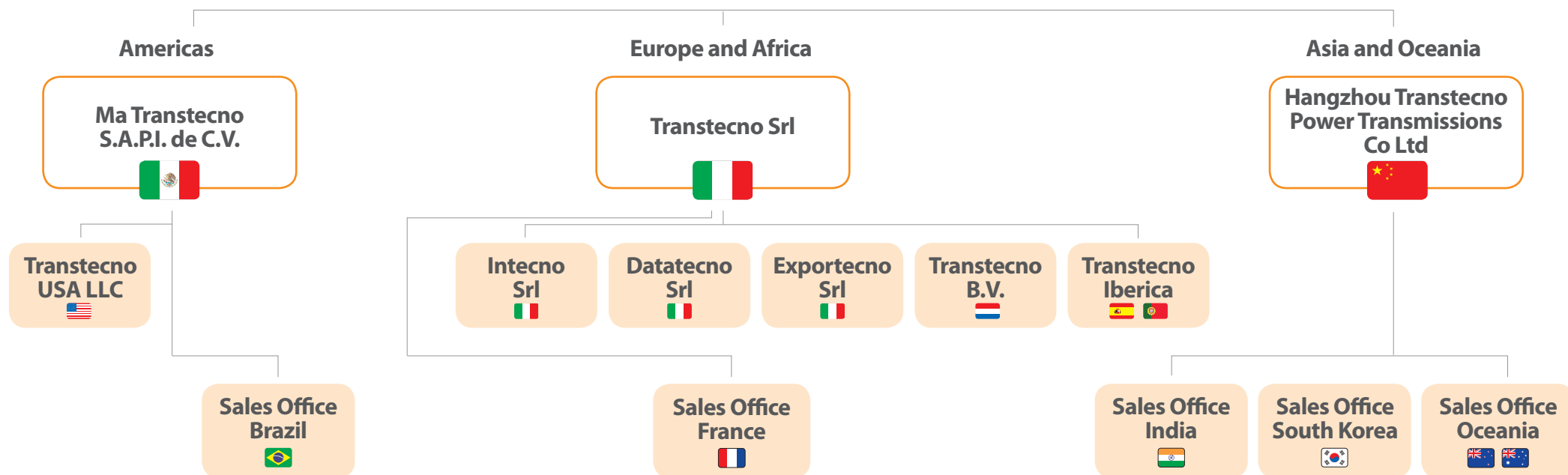

MEXICO
Ma Transtecno S.A.P.I. de C.V.
 Av. Mundial # 176,
 Parque Industrial JM Apodaca,
 Nuevo León, C.P. 66600
 MEXICO
 T +52 8113340920
www.transtecno.com.mx



ITALY
Transtecno Srl
 Via Caduti di Sabbiano, 11/D-E
 40011 Anzola dell'Emilia (BO)
 ITALY
 T+39 051 64 25 811
 F +39 051 73 49 43
www.transtecno.com



ITALY
Intecno Srl
 Via Caduti di Sabbiano, 9/E
 40011 Anzola dell'Emilia (BO)
 ITALY
 T +39 051 199 85 350
 F +39 051 199 85 361
www.intecno-srl.com



NETHERLANDS
Transtecno B.V.
 De Stuwdam, 43 - Ind. Terrein
 Wieken/Vinkenhoef - 3815 KM
 Amersfoort - NETHERLANDS
 Tel: +31(0) 33 45 19 505
 Fax: +31(0) 33 45 19 506
www.transtecno.nl



SPAIN
Transtecno Ibérica
The Modular Gearmotor, S.A.
 C/Enginy, 2 Nave 6
 08850 Gavà (Barcelona) - SPAIN
 Tel: +34 931 598 950
www.transtecno.es



CHINA
Hangzhou Transtecno Power Transmissions Co Ltd
 No.4 Xiuyan Road Fengdu
 Industry Zone, Pingyao Town
 Yuhang District, Hangzhou City,
 Zhejiang Province 311115 - CHINA
 T +86 571 86 92 02 60
 F +86 571 86 92 18 10
www.transtecno.cn

Transtecno Group

sales force

-  MAIN COMPANY
-  COMPANY
-  SALES OFFICE

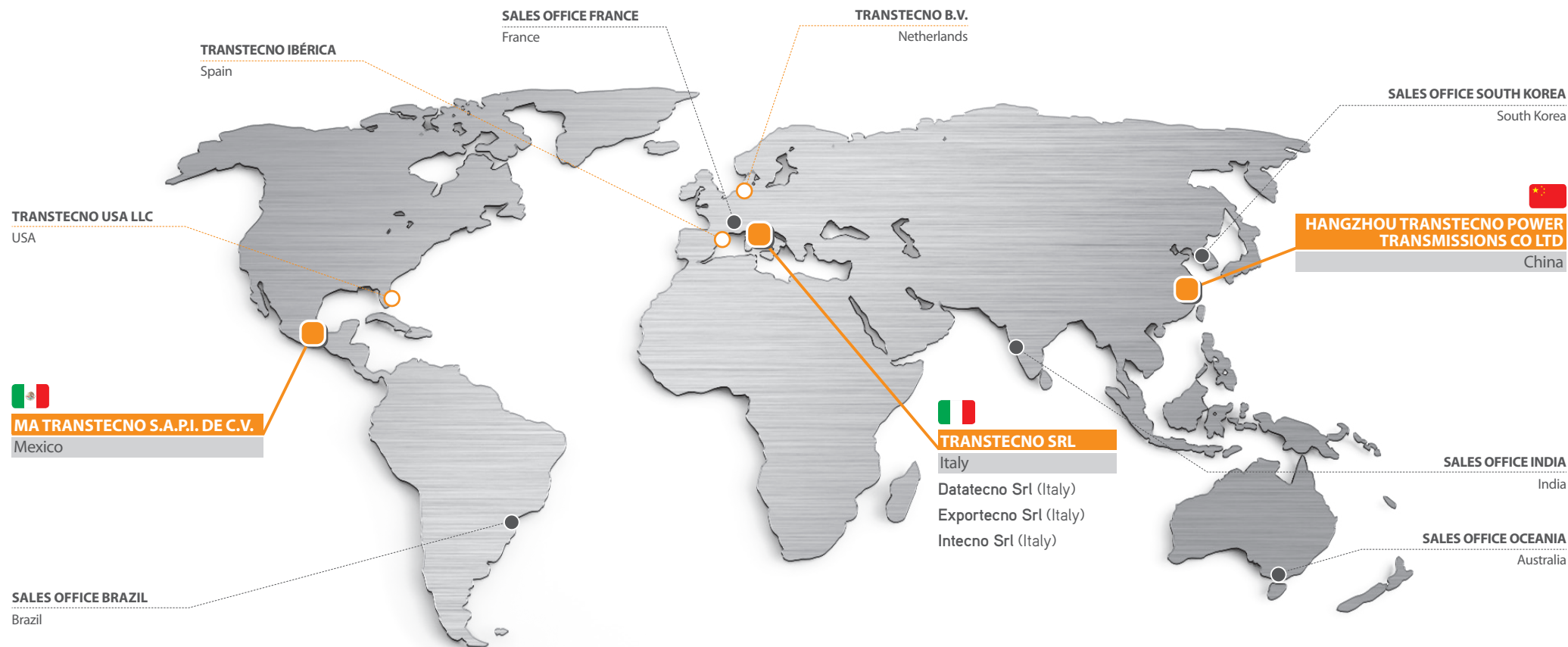
**TRANSTECNO USA LLC**

5440 S.W.
156th Place Miami,
FL 33185 - USA
Tel: +1 (305) 220-4423
Fax: +1 (305) 220-5945
usaoffice@transtecno.com

SALES OFFICE BRAZIL

Rua Dr. Freire Alemão
155 / 402 - CEP. 90450-060
Auxiliadora Porto Alegre
RS - BRAZIL
Tel: +55 51 3251 5447
Fax: +55 51 3251 5447
Mobile: +55 51 811 45 962
braziloffice@transtecno.com
www.transtecno.com.br

SALES OFFICE FRANCE

12 Impasse des Mûriers
38300 Ruy
France
Tel: +33 (0) 6 85 12 09 87
Fax-Italy: +39 051 733 904
franceoffice@transtecno.com
www.transtecno.fr

SALES OFFICE INDIA

A/10, Anagha, S.N.
Road, Mulund (W)
Mumbai
400080 - INDIA
Tel: +91 982 061 46 98
Fax-Italy: +39 051 733 904
indiaoffice@transtecno.com

SALES OFFICE SOUTH KOREA

D-304 Songdo BRC
Smart Valley 30,
Songdomirae-ro, Yeonsu-gu,
Incheon, 406-840 - SOUTH KOREA
Tel: +82 70 8288 2107
Fax: +82 32 815 2107
Mobile: +82 10 5094 2107
koreaoffice@transtecno.com

SALES OFFICE OCEANIA

44 Northview drive
Sunshine west 3020
Victoria - AUSTRALIA
Tel: +61 03 9312 4722
Fax: +61 03 9312 4714
Mobile: +61 0438 060 997
oceaniaoffice@transtecno.com
www.transtecno.com.au

EXPORTECNO SRL

Via Caduti di Sabbiano 11/C
40011 Anzola dell'Emilia
(BO) - ITALY
Tel: +39 051 733 304
Fax: +39 051 650 82 05

DATATECNO SRL

Via Caduti di Sabbiano 11/C
40011 Anzola dell'Emilia
(BO) - ITALY
Tel: +39 051 733 320
Fax: +39 051 650 48 56

Key Personnel

contacts

| Transtecno Group | | | |
|--|-----------------------------|-------------------------------------|-----------------------|
| President | Claudio Lorenzoni | claudio.lorenzoni@transtecno.com | +39 051 6425811 |
| Transtecno Srl - Italy | | | |
| Vice President for Sales & Marketing | Stefano Sabattini | stefano.sabattini@transtecno.com | +39 051 6425840 |
| Sales Area Manager | Massimo Zambonelli | massimo.zambonelli@transtecno.com | +39 051 6425834 |
| | Rodolfo Martelli | rodolfo.martelli@transtecno.com | +39 051 6425855 |
| | Andrea Bonechi | andrea.bonechi@transtecno.com | +39 051 6425804 |
| | Michele Martelli | michele.martelli@transtecno.com | +39 051 6425836 |
| | Fausto Santarelli | fausto.santarelli@transtecno.com | +39 0742 320286 |
| | Marco Rafanelli | marco.rafanelli@transtecno.com | +39 051 6425865 |
| Domestic Sales Manager | Andrea Malverti | andrea.malverti@transtecno.com | +39 051 6425805 |
| Domestic Sales Dept. Operations Manager | Stefania Ghelfi | stefania.ghelfi@transtecno.com | +39 051 6425814 |
| Export Dept. Operations Manager | Agnese Gaia | agnese.gaia@transtecno.com | +39 051 6425825 |
| DC Motors Product Manager | Alexandros Aposkitis | alexandros.aposkitis@transtecno.com | +39 051 6425850 |
| MiniTecno Domestic Sales Manager | Corrado Orlando | corrado.orlando@minitecno.com | +39 335 5629992 |
| Technical & Purchase Director | Sergio Bisi | sergio.bisi@transtecno.com | +39 051 6425811 |
| Pre & After Sales Manager | Sandro Ghedini | sandro.ghedini@transtecno.com | +39 051 6425852 |
| Technical Dept. Manager | Guglielmo Galli | guglielmo.galli@transtecno.com | +39 051 6425813 |
| Logistics Manager | Gianni Visicchio | gianni.visicchio@transtecno.com | +39 051 6425849 |
| Hangzhou Transtecno Power Transmissions Co Ltd - China | | | |
| General Manager | Richard Shou | richard.shou@transtecno.com | +86 571 86923076 |
| Operation Director | Jason Gu | jason.gu@transtecno.com | +86 571 86921571 |
| Chief Engineer | Bob Mao | bob.mao@transtecno.com | +86 571 86920260 803 |
| Engineering & Quality Manager | Bob Zhao | bob.zhao@transtecno.com | +86 571 86920260 831 |
| Administration & HR Manager | Katharine Lin | katharine.lin@transtecno.com | +86 571 86921136 |
| Financial Manager | Alice Ye | alice.ye@transtecno.com | + 86 571 86920260 812 |
| Manufacturing Manager | Jack Jin | jack.jin@transtecno.com | +86 571 86920260 846 |
| Planning Manager | Lynne Wong | lynne.wong@transtecno.com | +86 571 86920260 807 |

Key Personnel

contacts

Ma Transtecno S.A.P.I. de C.V - Mexico

| | | | |
|-------------------------|---------------------------------|----------------------------------|-------------------|
| General Manager | Juan Carlos Macias | juancarlos.macias@transtecno.com | +52 81 13340920/3 |
| Plan Manager | Ing. Cesar Daniel Gamboa | cesar.gamboa@transtecno.com | +52 81 13340920/3 |
| Fabiola Garduño | Sales | ventasinternas@transtecno.com | +52 81 13340920 |
| Amelia Alvarado | Logistics | embarques@transtecno.com | +52 81 13340920 |
| Juliana Rios | Marketing | marketingmtn@transtecno.com | +52 81 13340920 |
| Adriana Puente | Administration | administracion@transtecno.com | +52 81 13340920 |
| Angeles Gonzalez | Administration Assistant | adminasist@transtecno.com | +52 81 13340920 |

Transtecno B.V. - Netherlands

| | | | |
|--|--------------------------|--------------------------------|-------------------|
| General Manager | Jos van Tuyl | jos.vantuyl@transtecno.nl | +31(0) 33 4519505 |
| Operations Manager | Marcel van Hoegee | marcel.vanhoegee@transtecno.nl | +31(0) 33 4519505 |
| Purchase & Logistic Manager | Roy Hoffland | roy.hoffland@transtecno.nl | +31(0) 33 4519505 |
| Esther Harpe | Marketing | esther.harpe@transtecno.nl | +31(0) 33 4519505 |

Transtecno USA LLC - USA

| | | | |
|-------------------------------|----------------------------------|-----------------------------|-------------------|
| General Manager | Manuel "Manny" Garcia Jr. | manny.garcia@transtecno.com | +1 (305) 220-4423 |
| Purchasing & Sales | Marcella Romaguera | usaoffice@transtecno.com | +1 (305) 220-4423 |

Transtecno Ibérica The Modular Gearmotor, S.A. - Spain

| | | | |
|------------------------|------------------------|--------------------------------|----------------|
| General Manager | Ferran González | ferran.gonzalez@transtecno.com | +34 602 251686 |
| Sales Manager | Enric Deu | enric.deu@transtecno.com | +34 602 251685 |

Sales Offices

| | | | |
|---------------------------------|--------------------------|------------------------------|--------------------|
| Sales Office Brazil | Luiz Lentz Junior | braziloffice@transtecno.com | +55 51 32515447 |
| Sales Office Oceania | Darren Molloy | oceaniaoffice@transtecno.com | +61 03 93124722 |
| Sales Office South Korea | Joseph Choi | koreaoffice@transtecno.com | +82 70 82882107 |
| Sales Office India | Sameer N. Vaidya | indiaoffice@transtecno.com | +91 98 20614698 |
| Sales Office France | Jean-Marc Saino | franceoffice@transtecno.com | +33 (0) 68 5120987 |

Key Personnel

contacts

Intecno Srl - Italy

| | | | |
|------------------------|-----------------------|--------------------------------|------------------|
| General Manager | Moreno Ferrari | moreno.ferrari@intecno-srl.com | +39 051 19985353 |
|------------------------|-----------------------|--------------------------------|------------------|

Exportecno Srl - Italy

| | | | |
|--------------------------------|----------------------------|------------------------------------|----------------|
| Trading Company Manager | Elisabetta Rambaldi | elisabetta.rambaldi@transtecno.com | +39 051 733304 |
|--------------------------------|----------------------------|------------------------------------|----------------|

Datatecno Srl - Italy: Corporate Services

| | | | |
|------------------------------------|-----------------------------|--|-----------------|
| Corporate Marketing Manager | Paolo Montanari | paolo.montanari@datatecno-srl.com | +39 051 6425842 |
| | Valentina Bosi | valentina.bosi@datatecno-srl.com | +39 051 6425845 |
| Corporate Account Manager | Mariagrazia Pareschi | mariagrazia.pareschi@datatecno-srl.com | +39 051 6425816 |
| Corporate IT Manager | Giampietro Peli | giampietro.peli@datatecno-srl.com | +39 051 6425810 |

Stock products

Torques up to 1.000 Nm 8.800 lb-in

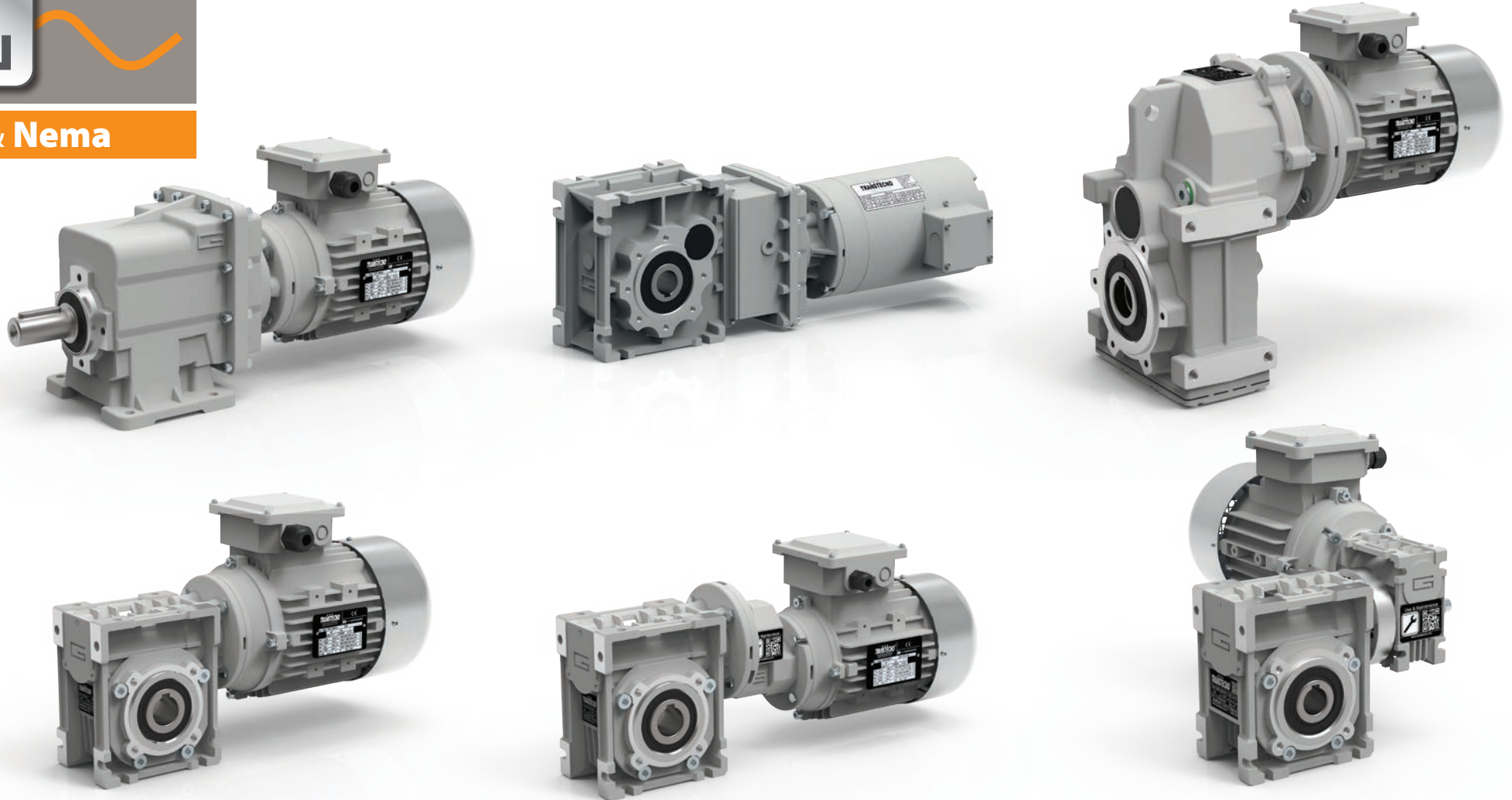

Stock products

Torques up to 3.500 Nm 31.000 lb-in

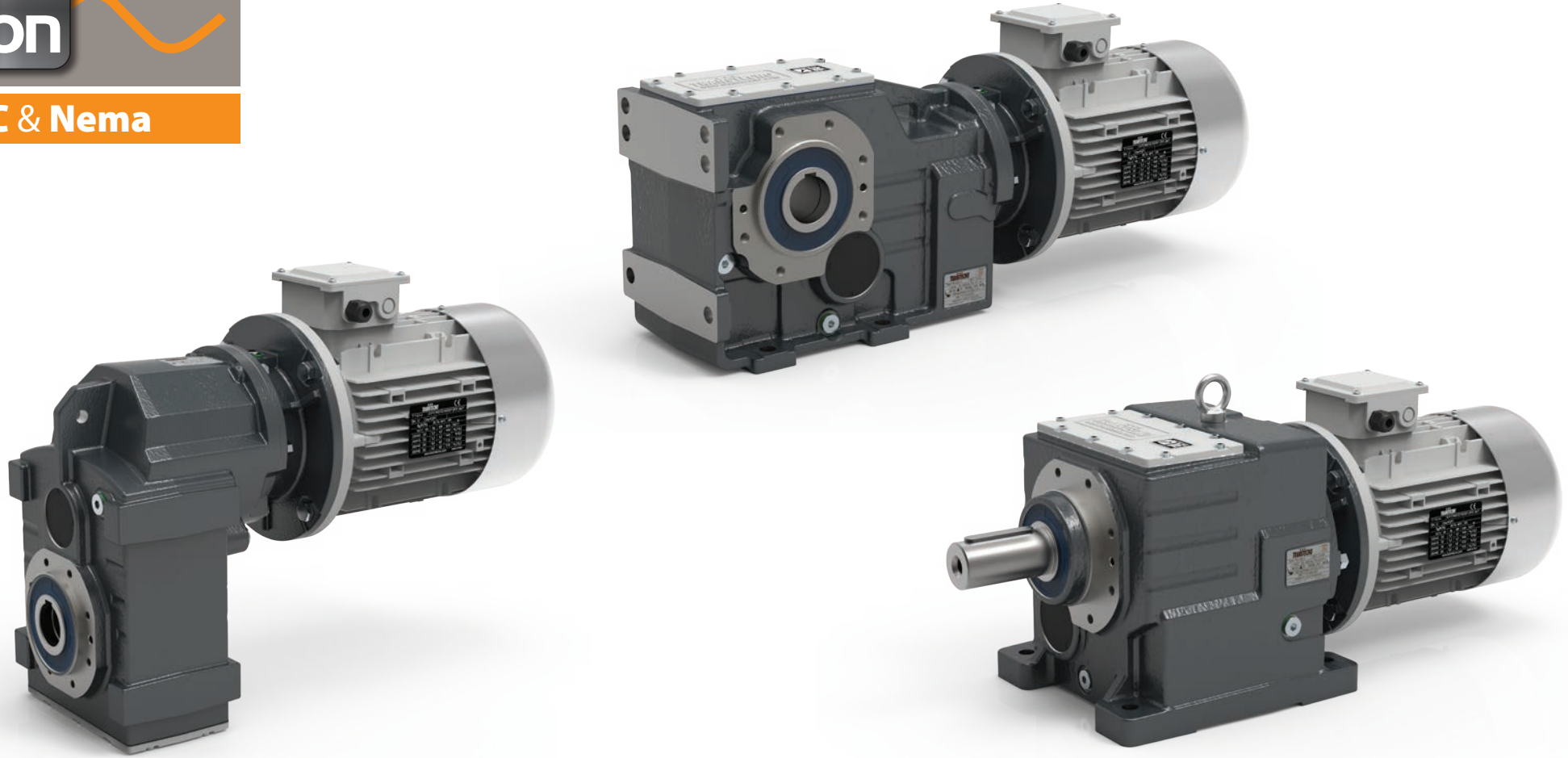

Stock products

Torques up to 500 Nm

Alu DC

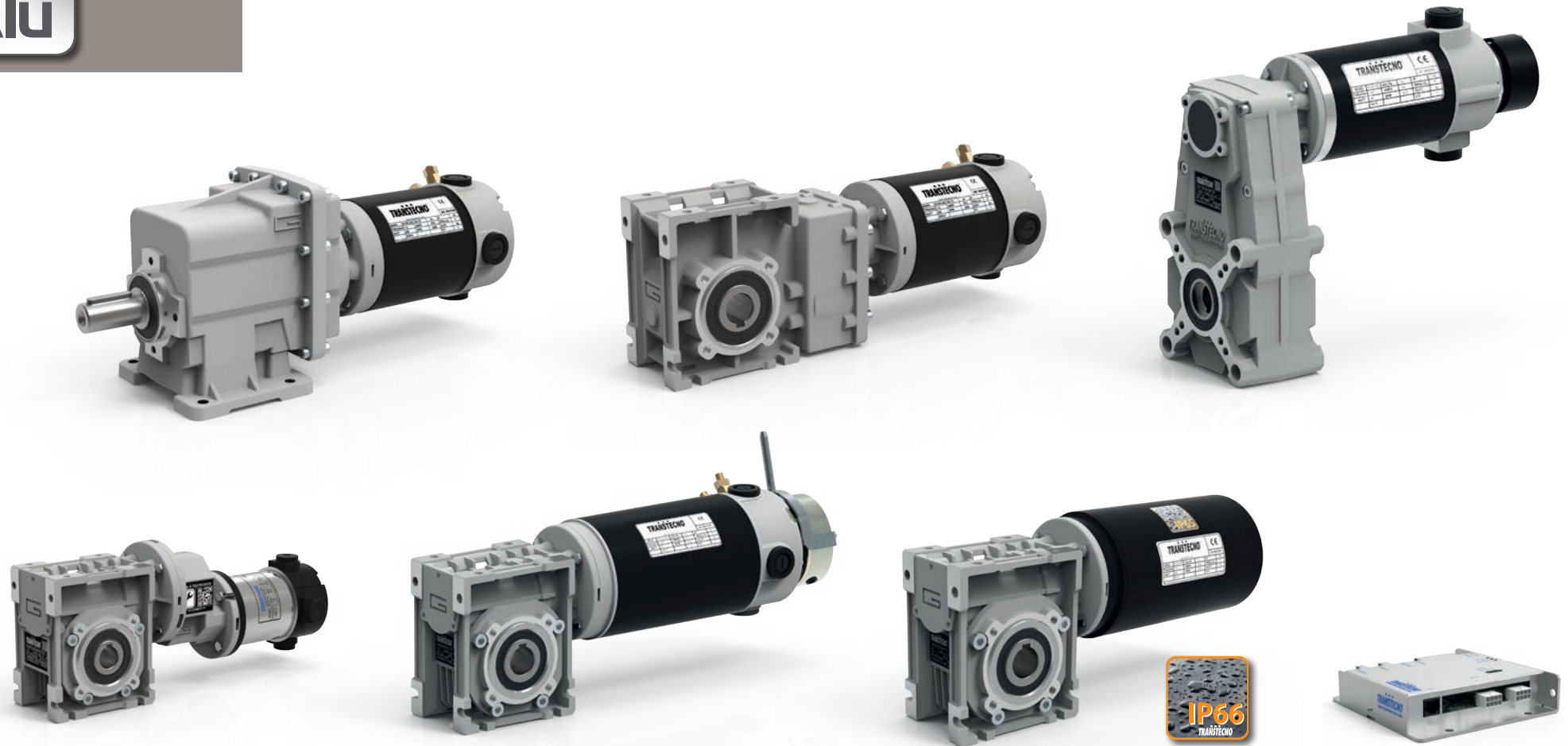

IP66
TRANSTECNO

Stock products

Torques up to 500 Nm

Alu

BLDC

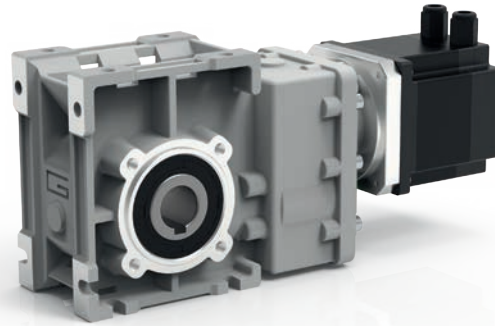

Stock products

Torques up to 90 Nm

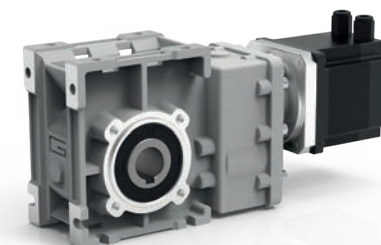
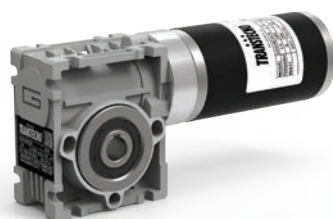

Products by market



Poultry&Pig Tecno

The gearmotors for farm equipment

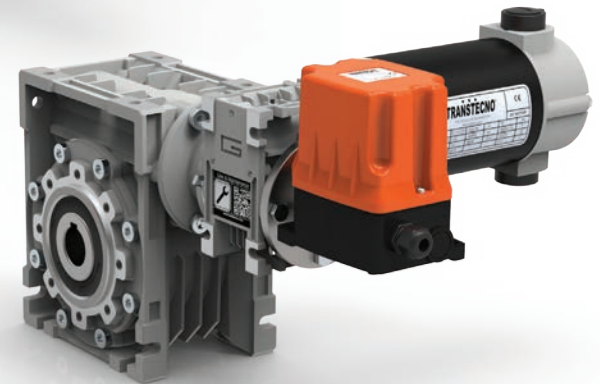
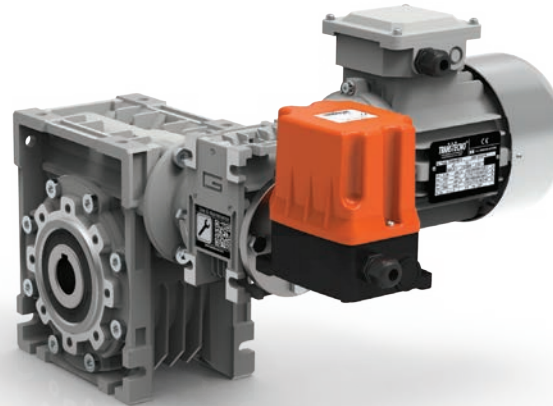
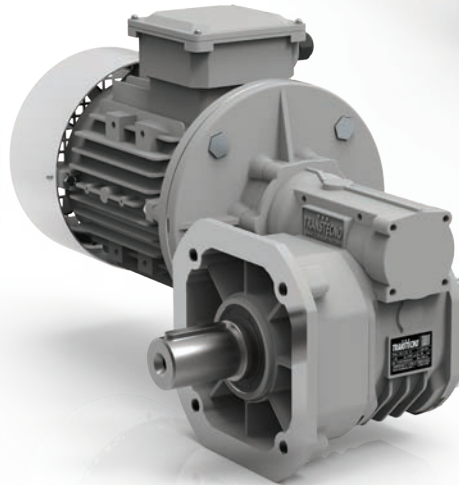
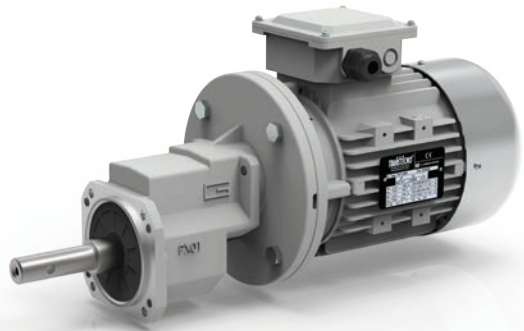

Products by market



Fire  **Tecno**
The gearmotors for bioenergy boilers

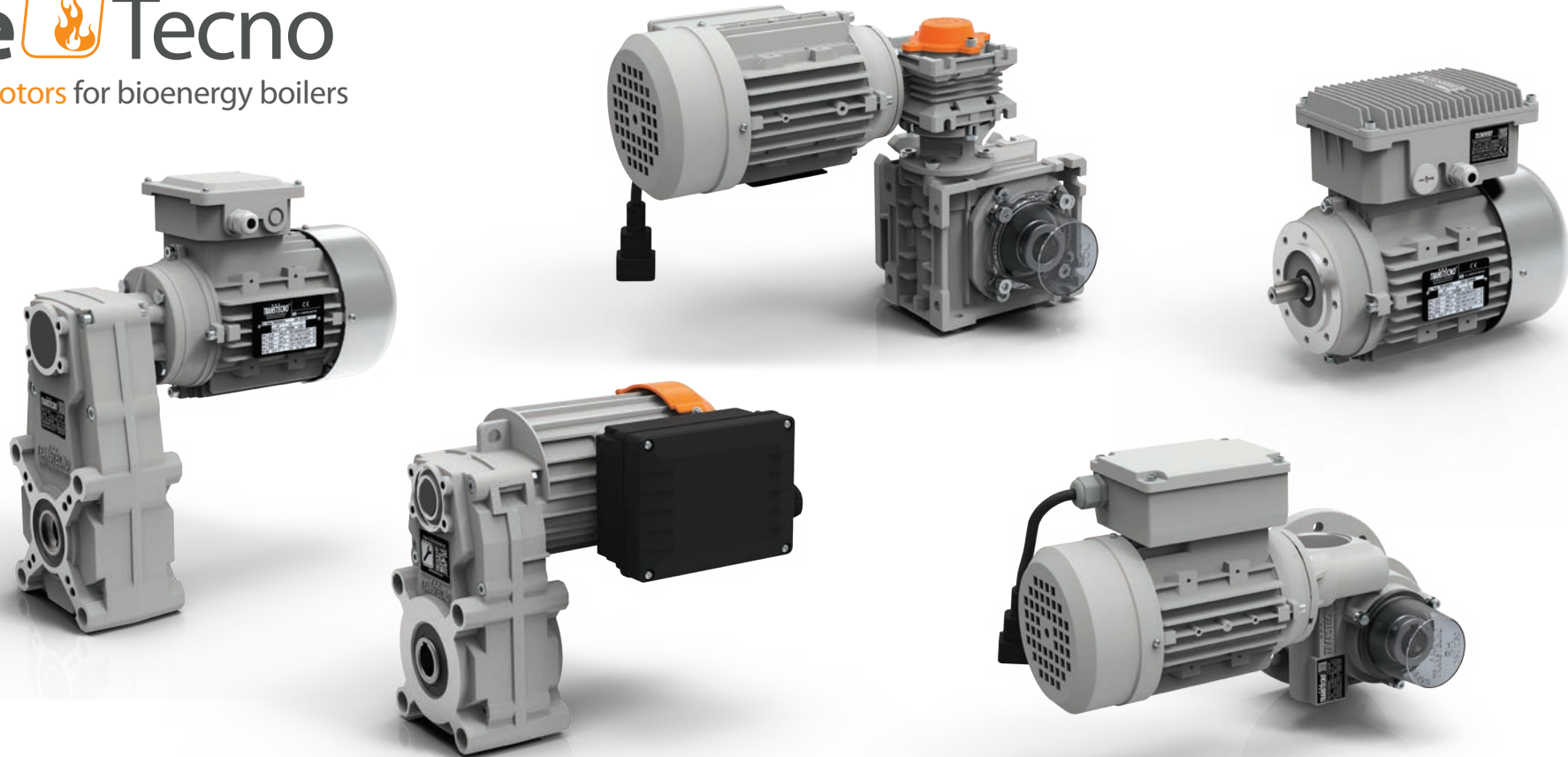

Products by market



Solar  **Tecno**
Solar tracker systems

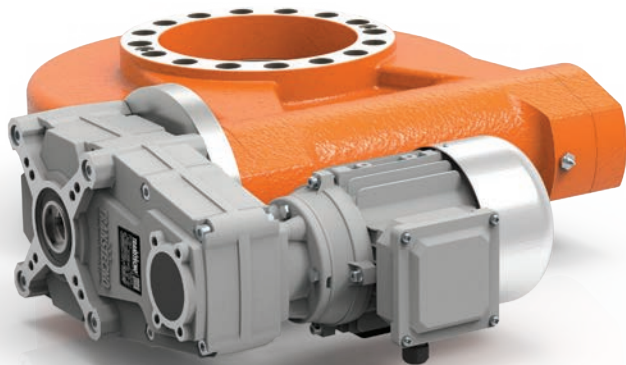

Products by market



Car-Wash Tecno

The **garmotors** for car wash equipment



Transtecno

facts and figures

Sales Transtecno Group in EUR million / year

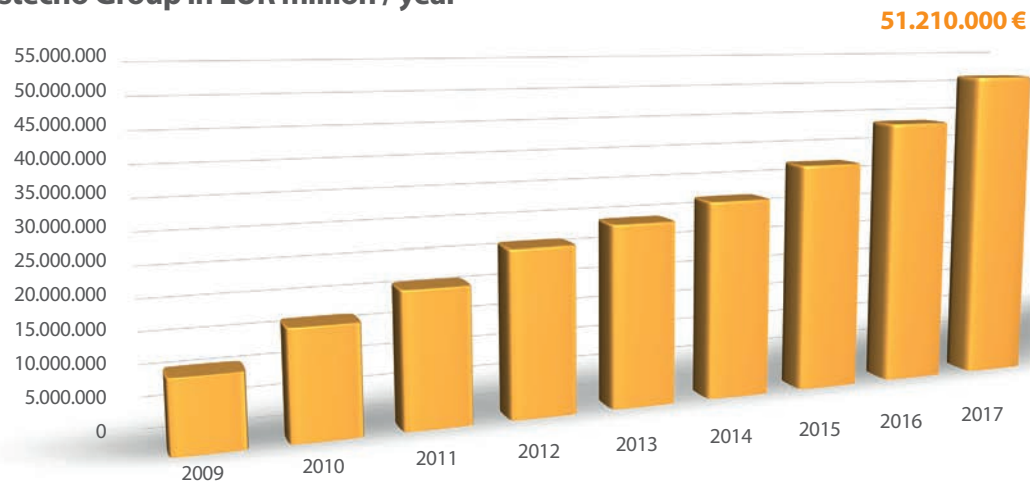

Staff Transtecno Group

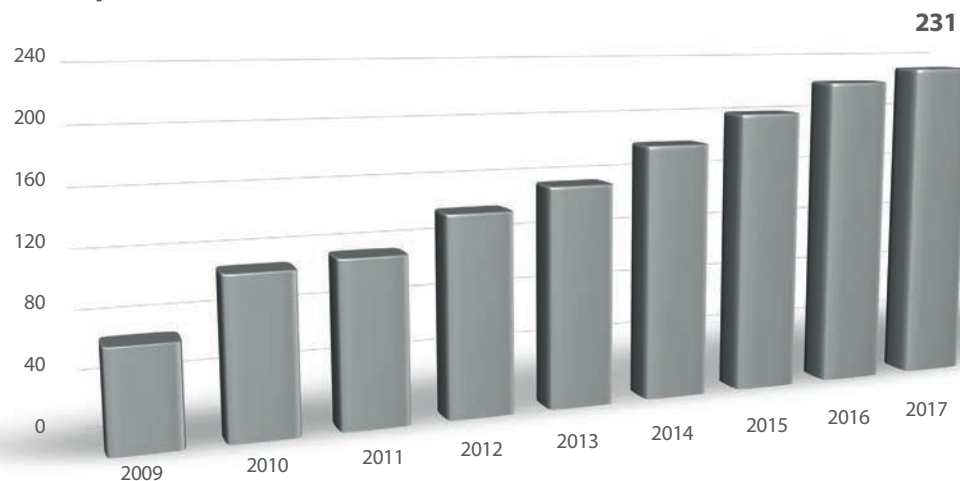

Transtecno companies m² covered surface

5.000 m² TRANSTECNO SRL



11.500 m² HANGZHOU TRANSTECNO POWER TRANSMISSIONS CO LTD



1.325 m² MA TRANSTECNO S.A.P.I. de C.V



Transtecno Srl - Italy

Company registration number: BO n. 03247851201

VAT number: IT 03247851201

| Bank account | Currency | Bank code | Account N. | SWIFT code | IBAN code |
|---|----------|-------------|---------------|-----------------|-----------------------------------|
| BANCA POPOLARE DELL'EMILIA ROMAGNA Fil. Anzola Emilia - Italy | EUR | 05387 36580 | 000000053673 | BP MO IT 22 XXX | IT 56 S 05387 36580 0000000 53673 |
| CARISBO GRUPPO INTESA SAN PAOLO FIL. Imprese Bologna Ovest - Calderara di Reno (BO) - Italy | EUR | 06385 36587 | 0740000 3722L | IBS PIT 2B | IT 86 L 06385 36587 07400003722L |
| BANCA NAZIONALE DEL LA VORO FIL. San Giovanni in persiceto (BO) - Italy | EUR | 01005 37060 | 000000003964 | BNL II TRR | IT 25 M 010 0537 0600 00000003964 |
| UNICREDIT BANCA Bologna - Italy | EUR | 02008 02435 | 000 001222121 | UNCR IT M1BA2 | IT 03 P 02008 02435 000001222121 |
| BANCA DI BOLOGNA Bologna - Italy | EUR | 08883 36580 | 017000024285 | BDBOIT21ANZ | IT 33 N 08883 36580 017000024285 |

Hangzhou Transtecno Power Transmissions Co Ltd - China

Company registration number: 330100400022323

Identify number: 91330100796690296W

| Bank account | Currency | Account N. | SWIFT BIC | Intermediary Bank and Swift |
|--|----------|----------------------|-------------|--|
| BANK OF HANGZHOU CO. LTD | EUR | 75168100226789 | HZCBCN2HXXX | KBC BANK NV SWIFT: KRED BE BB |
| | USD | 75168100226563 | HZCBCN2HXXX | WACHOVIA BANK NEW YORK, INTERNATIONAL BRANCH, U.S.A. SWIFT: PNBUS3NNYC |
| INDUSTRIAL AND COMMERCIAL BANK OF CHINA ZHEJIANG BRANCH | EUR | 1202083309838001061 | ICBKCNBJZJP | Industrial And Commercial Bank Of China, Frankfurt / Main Swift BIC: ICBKDEFF |
| | USD | 1202083309814002564 | ICBKCNBJZJP | 04-092-336 Deutsche Bank Trust Company Americas New York Chips:103 Swift BIC:BKTRUS33 |
| CHINA CONSTRUCTION BANK ZHEJIANG YUHANG SUB-BRANCH | EUR | 33033008800220506947 | PCBCCNBJZJX | |
| | USD | 33014008800220506937 | PCBCCNBJZJX | |
| BANK OF CHINA YUHANG SUB-BRANCH PINGYAO OFFICE | EUR | 366268852534 | BKCHCNBJ910 | |
| | USD | 367568853255 | BKCHCNBJ910 | |

Ma Transtecno S.A.P.I. de C.V. - Mexico

RFC: MTR - 140604-RN6

| Bank account | Currency | Bank code | Account N. | SWIFT code | IBAN code | Beneficiary |
|--|----------|-----------|------------------------|------------|---|--------------------------|
| BANORTE Nuevo Leon -Mexico Domestic transfer | MXN | 021000018 | 0725-8000-2400-2475-82 | MENOMXMT | 0240-0247-58 | |
| BANAMEX Nuevo Leon -Mexico Sucursal: 7006 Domestic transfer | MXN | BNMXMXMM | 0025-8070-0643-2212-39 | BNMXMXMM | 4322123 | |
| THE BANK OF NEW YORK MELLON BRANCH New York, NY - USA International Payments | USD | 021000018 | 8900111615 | IRVTUS3N | Reference 1 FFC MA TRANSTECNO S.A.P.I. DE C.V. Reference 2 145580347030002019 | Banco BASE, S.A., IBM |

Transtecno B.V. - Netherlands

Company registration number: 32103344

VAT number: NL 8133.56.027.B01

| Bank account | Currency | Bank code | Account N. | SWIFT code | IBAN code | Beneficiary |
|----------------------|----------|-----------|------------|------------|---------------------|-------------|
| ABN AMRO Bank | EUR | | 977323226 | ABNANL2A | NL14ABNA0 977323226 | |

Transtecno Ibérica The Modular Gearmotor, S.A. - Spain

VAT number: 66575861

| Bank account | Currency | Bank code | Account N. | SWIFT code | IBAN code | Beneficiary |
|--|----------|--------------|------------|------------|-------------------------------|-------------|
| BANCO SANTANDER Castelldefels, Barcelona - Spain | EUR | 0049 0766 71 | 2510711953 | BSCH ESMM | ES69 0049 0766 7125 1071 1953 | |

| Bank account | Currency | Bank code | Account N. | SWIFT code | Routing Number | Intermediary Bank and Swift: |
|--|----------|-----------|------------|------------|----------------|------------------------------|
| Transtecno USA, LLC - USA | | | | | | |
| TAX ID 38-3953597 | | | | | | |
| PROFESSIONAL BANK Coral Gables, FL – USA International wire transfer | USD | PRFLUS33 | 2405040 | PRFLUS33 | 067016574 | |
| PROFESSIONAL BANK Coral Gables, FL – USA Domestic transfer | USD | PRFLUS33 | 2405040 | | 067016574 | |

Intecno Srl - Italy

Company registration number: BO n. 02484601204
VAT number: IT 02484601204

| Bank account | Currency | Bank code | Account N. | SWIFT code | IBAN code |
|---|----------|-------------|--------------|-----------------|----------------------------------|
| BANCA POPOLARE DELL'EMILIA ROMAGNA Fil. Anzola Emilia - Italy | EUR | 05387 36580 | 000001288654 | BP MO IT 22 XXX | IT 59 J 05387 36580 000001288654 |

Exportecno Srl - Italy

Company registration number: BO n. 02495201200
VAT number: IT 02495201200

| Bank account | Currency | Bank code | Account N. | SWIFT code | IBAN code |
|---|----------|-------------|--------------|-----------------|----------------------------------|
| BANCA POPOLARE DELL'EMILIA ROMAGNA Fil. Anzola Emilia - Italy | EUR | 05387 36580 | 000001293856 | BP MO IT 22 XXX | IT 33 C 05387 36580 000001293856 |

Datatecno Srl - Italy

Company registration number: BO n. 02794701207
VAT number: IT 02794701207

| Bank account | Currency | Bank code | Account N. | SWIFT code | IBAN code |
|---|----------|-------------|--------------|-----------------|----------------------------------|
| BANCA POPOLARE DELL'EMILIA ROMAGNA Fil. Anzola Emilia - Italy | EUR | 05387 36580 | 000001667851 | BP MO IT 22 XXX | IT 13 O 05387 36580 000001667851 |



MÉXICO

Ma Transtecno S.A.P.I. de C.V.

Av. Mundial # 176, Parque Industrial
JM Apodaca, Nuevo León, C.P. 66600

MÉXICO

T +52 8113340920/3

www.transtecno.com.mx

ITALY

Transtecno Srl

Via Caduti di Sabbiano, 11/D-E
40011 Anzola dell'Emilia (BO)

ITALY

T+39 051 64 25 811

F +39 051 73 49 43

www.transtecno.com

CHINA

Hangzhou Transtecno Power

Transmissions Co Ltd

No.4 Xiuyan Road Fengdu Industry Zone,
Pingyao Town Yuhang District

Hangzhou City, Zhejiang Province 311115

CHINA

T +86 571 86 92 02 60

F +86 571 86 92 18 10

www.transtecno.cn